

Overview

HPE ProLiant DL180 Generation9 (Gen9)

The new standard for growing data center needs. Delivering an optimized 2U server, designed with the right balance of expandability, performance, reliability, and manageability—all in a new compact chassis. The ideal platform for SMBs and enterprises running applications, which need the right mix of compute and storage.

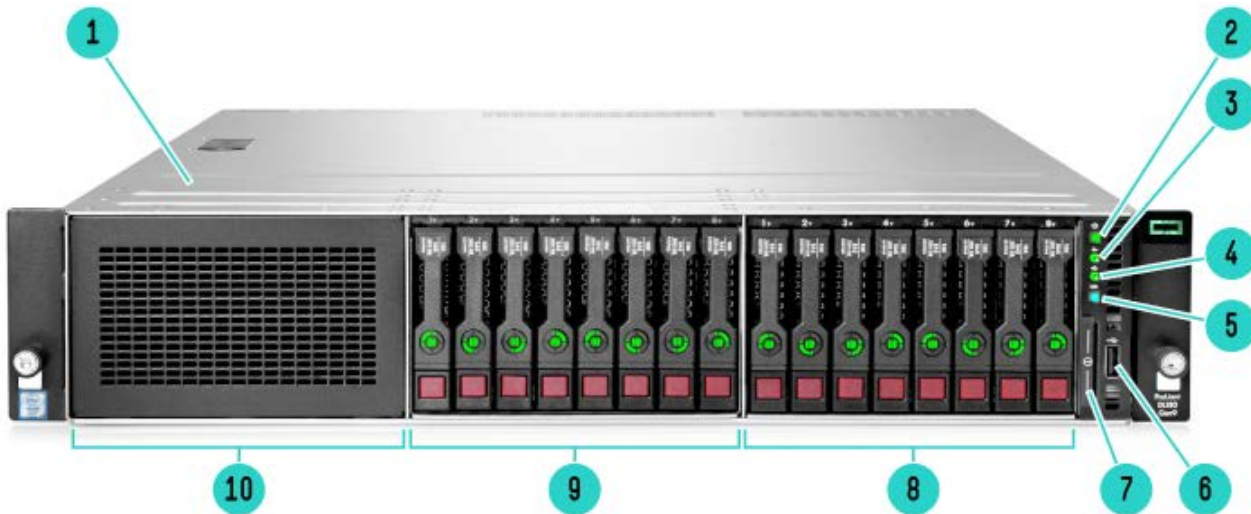

Front View

- | | | | |
|---|--|----|--|
| 1 | Access Panel (Top Cover) | 2 | Power On/Standby button and system power LED |
| 3 | Health LED | 4 | NIC status LED |
| 5 | UID button/LED | 6 | USB 2.0 connector |
| 7 | Serial label pull tab | 8 | Fixed 8-bay SFF drive cage (box 3) |
| 9 | 8-bay SFF drive cage bay (box 2, for the second 8-bay SFF drive cage option) | 10 | HPE Media Bay (box 1, for the optical drive cage option) |

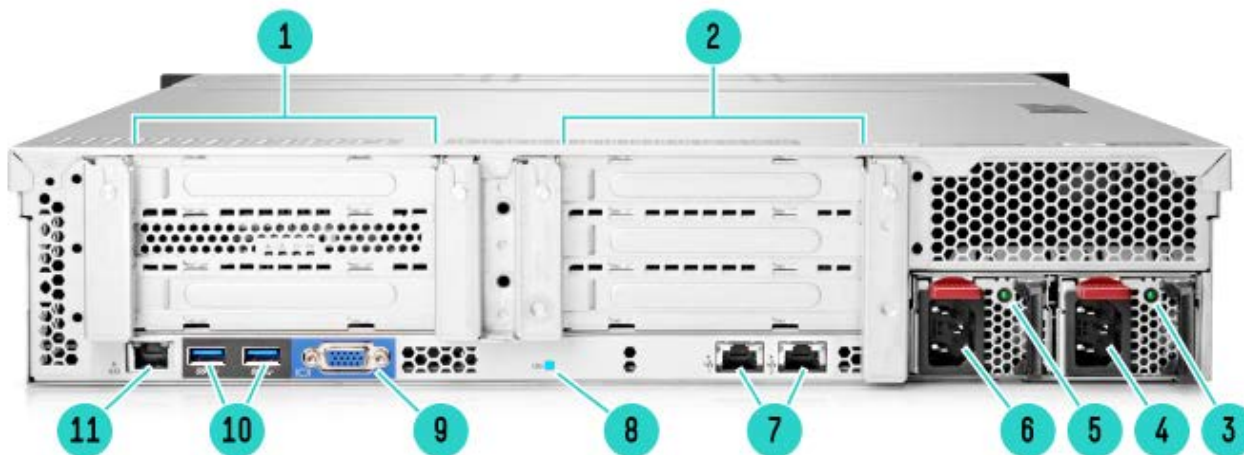

Rear view

Overview

- | | | | |
|----|--|----|---|
| 1 | PCIe3 slots 1-3 (primary, associated with processor 1) | 2 | PCIe3 slots 4-6 (secondary, associated with processor 2) |
| 3 | Power Supply 2 LED (Optional) | 4 | Power Supply 2 Power Connector (Optional)
NOTE: RPS shown in the picture. |
| 5 | Power Supply 1 LED (Optional) | 6 | Power Supply 1 Power Connector (Optional) |
| 7 | NIC connectors | 8 | UID LED |
| 9 | Video Connector | 10 | USB 3.0 Connectors |
| 11 | Dedicated iLO connector (optional) | | |

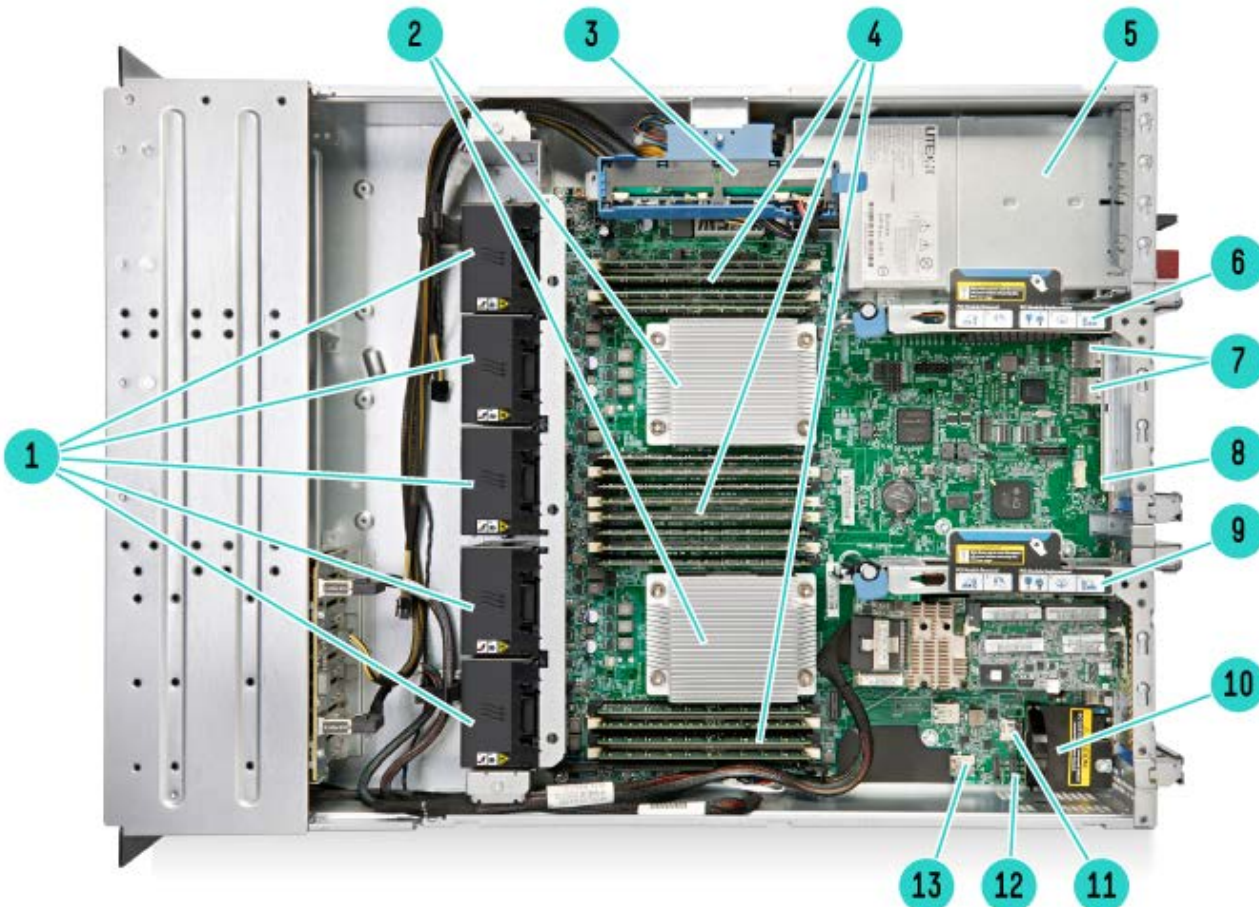

Internal View

- | | | | |
|----|---|----|--|
| 1 | Fan cage shown with 5 Hot-swap fans (for 2P Redundancy) | 2 | 2 Processors, heatsink showing, with HPE Smart Socket Guide |
| 3 | Optional HPE Smart Storage Battery | 4 | DDR4 DIMM slots. Shown fully populated in 16 slots (8 per processor) |
| 5 | Entry level power supply bay (1x900W shown)
NOTE: RPS (with one module) shown in the picture above. | 6 | Connection for second (optional) riser (Required second CPU) |
| 7 | Embedded 2x1GbE NIC | 8 | Flexible LOM sideband signal connector |
| 9 | Primary PCIe riser, standard | 10 | Dedicated iLO module connector |
| 11 | MicroSD card slot | 12 | SATA optical drive connector |
| 13 | Internal USB 3.0 connector (for USB flash devices) | | |

What's New

- New SAS LFF HDDs up to 10TB capacity now brings the DL180 maximum storage capacity to 120TB SAS

Standard Features

NOTE: For more information regarding Intel Xeon processors, please see the following <http://www.intel.com/xeon>.

Processor	Model	CPU frequency	Cores	L3 Cache	Power	QPI	DDR4 Hz
One of the following depending on model	E5-2660v3	2.6GHz	10	25MB	105W	9.6GT/s	2133
	E5-2650v3	2.3GHz	10	25MB	105W	9.6GT/s	2133
	E5-2650Lv3	1.8GHz	12	30MB	65W	9.6GT/s	2133
	E5-2640v3	2.6GHz	8	20MB	90W	8.0GT/s	1866
	E5-2630v3	2.4GHz	8	20MB	85W	8.0GT/s	1866
	E5-2630Lv3	1.8GHz	8	20MB	55W	8.0GT/s	1866
	E5-2623v3	3.0GHz	4	10MB	105W	8.0GT/s	1866
	E5-2620v3	2.4GHz	6	15MB	85W	8.0GT/s	1866
	E5-2609v3	1.9GHz	6	15MB	85W	6.4GT/s	1600
	E5-2603v3	1.6GHz	6	15MB	85W	6.4GT/s	1600
	E5-2695v4	2.1GHz	18	45MB	120W	9.6GT/s	2400
	E5-2683v4	2.1GHz	16	40MB	120W	9.6GT/s	2400
	E5-2680v4	2.4GHz	14	35MB	120W	9.6GT/s	2400
	E5-2660v4	2.0GHz	14	35MB	105W	9.6GT/s	2400
	E5-2650v4	2.2GHz	12	30MB	105W	9.6GT/s	2400
	E5-2650Lv4	1.7GHz	14	35MB	65W	9.6GT/s	2400
	E5-2640v4	2.4GHz	10	25MB	90W	8.0GT/s	2133
	E5-2630v4	2.2GHz	10	25MB	85W	8.0GT/s	2133
	E5-2630Lv4	1.8GHz	10	25MB	55W	8.0GT/s	2133
	E5-2623v4	2.6GHz	4	10MB	85W	8.0GT/s	2133
E5-2620v4	2.1GHz	8	20MB	85W	8.0GT/s	2133	
E5-2609v4	1.7GHz	8	20MB	85W	6.4GT/s	1866	
E5-2603v4	1.7GHz	6	15MB	85W	6.4GT/s	1866	

Chipset

One of the following depending on model

Intel® C610 Series Chipset

Intel® E5-2600v3 Processor Family

Intel® E5-2600v4 Processor Family

NOTE: For more information regarding Intel chipsets, please see the following URL: <http://www.intel.com/products/server/chipsets/>

On System Management Chipset

One of the following depending on model

HPE iLO (Firmware HPE iLO4 2.0 or later) 2GB NAND

NOTE: Read and learn more in the [iLO QuickSpecs](#).

Memory

One of the following depending on model

Type:

HPE SmartMemory

DDR4 Registered (RDIMM) or Load Reduced (LRDIMM)

DIMM Slots Available 16 (8 DIMM slots per processor, 4 channels per processor, 2 DIMMs per channel)

Maximum Capacity 1TB (16 x 64GB LRDIMM @2400MHz) (LRDIMM)

Standard Features

Maximum Capacity (RDIMM)	512GB (16 x 32GB RDIMM @2400MHz)
--------------------------	----------------------------------

Memory Protection

Advanced ECC
One of the following depending on model

Advanced ECC	Advanced ECC uses single device data correction to detect and correct single and all multibit error that occurs within a single DRAM chip.
Online spare	Memory online spare mode detects a rank that is degrading and switches operation to the spare rank.
Memory Mirroring Inter-Socket	Memory mirroring inter-socket stores a copy of memory with dynamic failover in case of failure. Once a DIMM in a mirrored set is detected as failed, the mirror failover uses its mirrored DIMM.

Network Controller

HPE Ethernet 1Gb 2-Port 361i Adapter
One of the following depending on model

HPE Ethernet 1Gb 2-Port 361i Adapter

Expansion Slots

Primary Riser (Optional)

Expansion Slots #	Technology	Bus Width	Connector Width	Bus Number	Form Factor	Notes
1	PCIe 3.0	x8	x8		Full-height, full-length slot	
2	PCIe 3.0	x8	x8		Full-height, half-length slot	
3	PCIe 3.0	x8	x8		Full-height, half-length slot	

NOTE: This riser can be used with both CPU 1 and CPU 2

NOTE: Bus Width data indicates the number of physical electrical lanes running to the connector.

Primary Riser (Optional)

Expansion Slots #	Technology	Bus Width	Connector Width	Bus Number	Form Factor	Notes
1	PCIe 3.0	x16	x16		Full-height, full-length slot	
2	PCIe 3.0	x8	x8		Full-height, half-length slot	

NOTE: This riser can be used with both CPU 1 and CPU 2

Riser with Flexible LOM (Optional)

Expansion Slots #	Technology	Bus Width	Connector Width	Bus Number	Form Factor	Notes
1	PCIe 3.0	x8	x8		Full-height, full-length slot	
2	PCIe 3.0	x8	x8		Full-height, half-length slot	
3	Flexible LOM				Full-height, half-length slot	Can only be used for FlexibleLOMs

NOTE: This riser is mandatory for installing FlexibleLOMs & can be used only with CPU 1.

NOTE: When populating slots on second riser, a second processor must be installed.

NOTE: One of the 3 risers has to be selected mandatorily.

Storage Controller

Entry Models
One of the following depending on model

Entry Models	HPE Dynamic Smart Array B140i Controller
Base Models	HPE Dynamic Smart Array B140i Controller
	HPE H240 FIO Smart Host Bus Adapter

Standard Features

Storage Models HPE Flexible Smart Array P840/4G FIO Controller

Performance Models HPE Flexible Smart Array P840/4G FIO Controller

NOTE: B140i provides support for up to 8 SATA drives and data transmission speeds up to 6Gb/s and supports RAID 0, 1 & 5.

NOTE: H240 Provides support for up to 8 SAS/SATA drives, data transmission speeds up to 12Gb/s and supports RAID 0, 1 & 5.

NOTE: P840 Provides support for up to 16 SAS/SATA drives, data transmission speeds up to 12Gb/s.

Internal Storage Devices	Optical Drives	Optional: DVD-ROM, DVD-RW NOTE: This option available with all 8SFF drive bay models only.
	One of the following depending on model	Hard Drives None ship standard
	Hard Drive Bays	8 SFF drive bays total with Optical Bay Optional: +8SFF drive bay (total of 16SFF drive bays) NOTE: The Optical Drive bay is not available with +8SFF drive bay optional upgrade. 8 LFF drive bays total without Optical Bay 12 LFF drive bays total without Optical Bay Up to 4 Non-hot plug SATA 3.5" drives NOTE: Optical drive is not supported on LFF Model.

Maximum Internal Storage		CAPACITY	CONFIGURATION
One of the following depending on model	Hot Plug SFF SAS	32TB	16x2TB
	Hot Plug SFF SATA	32TB	16x2TB
	Hot Plug LFF SAS	120TB	12x10TB
	Hot Plug LFF SATA	120TB	12x10TB
	Hot Plug SFF SAS SSD	61.4TB	16x3.84TB
	Hot Plug SFF SATA SSD	61.4TB	16x3.84TB
	Hot Plug LFF SATA SSD	46.08TB	12x3.84TB
	Non Hot Plug LFF SATA	32TB	8x4TB

Power Supply	HPE 550W FIO Power Supply
	One of the following depending on model
	HPE 900W Redundant Power Supply
	Looking for high-efficiency power solutions at an entry-level price for your ProLiant Gen9 Essential Server? HPE Entry-Level Power Supplies offer an optimized set of features with options for both redundant and non-redundant power configurations.

The HPE 550W FIO Power Supply offers Silver-certified 80 Plus power efficiency (up to 89%) with an optimized set of features for non-redundant power configurations.

The HPE 900W AC 240VDC Power Input Module with Power Backplane can be configured to support power redundancy in ProLiant servers that offer only a single power supply bay, providing additional protection against power loss. With an 80 Plus Gold power efficiency rating (up to 92%), this power option helps to reduce operating expenses while protecting against trapped power capacity in the data center. Hot-plug AC power input modules allow for better serviceability with fast and easy deployment and replacement.

System Fans	One of the following depending on model	1P model	Non-redundant	Redundant
			2 fans	4 fans
			Non-redundant	Redundant

Standard Features

2P model

4 fans

5 fans

NOTE: Customers may separately purchase redundant fans with the 725571-B21 option kit.

NOTE: Additional fans (two) are also included in -B21 processor option kits when upgrading from one processor to two processors.

Interfaces

Video 1 (Vaux Support)

LOM Network Ports 2x1GbE ports

HPE iLO Remote Management Network Port 1 GbE (Optional)

USB Up to 4 USB ports (standard);
Front: 1xUSB 2.0 std; (1xUSB3.0 optional upgrade with quick release ears)
Rear: 2xUSB 3.0
Internal: 1xUSB 3.0

Micro SD Slot 1 Micro SD

NOTE: The SD slot is not a hot-pluggable device. Customers should not attempt to plug an SD card into the SD slot while the server is powered.

NOTE: 8LFF & 12LFF drive cage models with Quick release latch rack ears supports front USB 3.0.

Operating Systems and Virtualization Software Support for ProLiant Servers

Microsoft Windows Server**Red Hat Enterprise Linux (RHEL)****SUSE Linux Enterprise Server (SLES)****Oracle Linux****VMware**

NOTE: For more information on HPE's Certified and Supported ProLiant Servers for OS and Virtualization Software and latest listing of software drivers available for your server, please visit our Support Matrix at: <http://www.hp.com/go/ossupport> and our driver download page <http://h20566.www2.hp.com/hpsc/swd/public/readIndex?sp4ts.oid=7252825>.

Upgradeability

One of the following depending on model

Upgradeable to 2 processors (36 Cores)

NOTE: Processor upgrade from E5-2600v3 to E5-2600v4 is supported for processors up to 105W.

Up to 16 DIMM slots available

NOTE: To take advantage of DIMMs 9-16, a second processor must be installed.

FlexibleLOM slot for 1GbE or 10GbE or QDR/FDR InfiniBand Networking Options

Optional 2 slot riser (x16, x8)

NOTE: To take advantage of the additional 2 PCI slot upgrade, a second processor must be installed.

Redundant Power Supply

Redundant Fan

Optical Drive (8 SFF only)

Industry Standard Compliance

ACPI 2.0b Compliant

PCIe 3.0 Compliant

PXE Support

WOL Support

Microsoft® Logo certifications

USB 3.0 Support

ASHRAE A3/A4

Standard Features

NOTE: Supports A3 & A4 extended ambience.

NOTE: Refer to technical specifications section for more details.

Graphics

Integrated Matrox G200eH2 video standard

- 1280 x 1024 (32 bpp)
- 1920 x 1200 (16 bpp)

HPE Server UEFI/Legacy ROM

Unified Extensible Firmware Interface (UEFI) is an industry standard that provides better manageability and more secured configuration than the legacy ROM while interacting with your server at boot time. HPE ProLiant Gen9 platform defaults to UEFI and can be factory or field configured for Legacy BIOS Boot Mode.

NOTE: The UEFI System Utilities function is analogous to the HPE ROM-Based Setup Utility (RBSU) of legacy BIOS. For more information, please visit <http://www.hpe.com/servers/uefi>

UEFI enables numerous new capabilities specific to HPE ProLiant servers such as:

- Secure Boot
- Operating system specific functionality
- Support for > 2.2 TB (using GPT) boot drives
- USB 3.0 Stack
- Embedded UEFI Shell
- Mass Configuration Deployment Tool using RESTful API for iLO 4
- PXE boot support for IPv6 networks
- Boot support for option cards that only support a UEFI option ROM
- Network Stack configurations

NOTE: For UEFI Boot Mode, boot environment and OS image installations should be configured properly to support UEFI.

NOTE: UEFI FIO Setting (758959-B22) can be selected to configure the system in Legacy mode in the factory for your HPE ProLiant Gen9 Server.

Form Factor

2U Rack form factor

One of the following 4/8/12 LFF and 8/16 SFF Drive Bay Version:

depending on model 3.44 (8.75 cm) Height x 17.54" (44.55 cm) Width x 23.9" (60.70 cm) Length

Embedded Management

HPE Integrated Lights-Out (HPE iLO)

Monitor your servers for ongoing management, service alerting, reporting and remote management with HPE iLO. Not available on ML10 Gen9. Learn more at <http://www.hpe.com/info/iLO>.

UEFI

Configure and boot your servers securely with industry standard Unified Extensible Firmware Interface (UEFI). Learn more at <http://www.hpe.com/servers/uefi>.

RESTful API

RESTful API for iLO 4 is Redfish 1.0 conformance for simplified server management such as configuration and maintenance tasks based on modern industry standards. Learn more at <http://www.hpe.com/info/restfulapi>.

Standard Features

Intelligent Provisioning Hassle free server and OS provisioning for 1 or few servers with Intelligent Provisioning. Learn more at <http://www.hpe.com/servers/intelligentprovisioning>.

Embedded Remote Support Hewlett Packard Enterprise embedded remote support, when used with Insight Online direct connect or HPE Insight Remote Support, allows HPE ProLiant servers to transmit hardware events directly to Hewlett Packard Enterprise or a Hewlett Packard Enterprise Authorized Partner for automated phone home support. Learn more at <http://www.hpe.com/info/insightonline/explore>.

Server utilities	Smart Update	Optimize firmware and driver updates with Smart Update solutions including Smart Update Manager (SUM) and Service Pack for ProLiant (SPP) and smart components. Learn more at http://www.hpe.com/servers/smartupdatemanager .
	HPE Systems Insight Manager (HPE SIM)	HPE SIM allows you to monitor the health of your HPE ProLiant Servers and HPE Integrity Servers, and also provides you with basic support for non-HPE servers. HPE SIM also integrates with Smart Update Manager to provide quick and seamless firmware updates. Learn more at http://www.hpe.com/servers/hpsim .
	Scripting Tool Kit and Windows PowerShell	Provision 1 to many servers using your own scripts to discover and deploy them with Scripting Tool Kit (STK) for Windows and Linux or Scripting Tools for Windows PowerShell. Learn more at http://www.hpe.com/servers/proliant/stk or http://www.hpe.com/servers/powershell .
	RESTful Interface Tool	RESTful Interface tool is a scripting tool to provision using RESTful API for iLO 4 to discover and deploy servers at scale. Learn more at http://www.hpe.com/info/resttool .
	HPE iLO Mobile Application	Enables the ability to access, deploy, and manage your server anytime from anywhere from select smartphones and mobile devices. For additional information please visit: http://www.hpe.com/info/ilo/mobileapp .
	HPE Insight Online	HPE Insight Online, available at no additional cost as part of your Hewlett Packard Enterprise warranty, Care Pack or contractual support agreement with Hewlett Packard Enterprise, is a personalized dashboard for simplified tracking of IT operations and support information from anywhere, anytime. Learn more at http://www.hpe.com/info/insightonline/explore .

Security

- Power-on password
- Serial interface control
- Administrator's password
- UEFI
- TPM 1.2
- TPM 2.0

NOTE: TPM 1.2 is not upgradable to TPM 2.0.

Warranty This product is covered by a global limited warranty and supported by HPE Services and a worldwide network of HPE Authorized Channel Partners resellers. Hardware diagnostic support and repair is

Standard Features

available for three years from date of purchase. Support for software and initial setup is available for 90 days from date of purchase. Enhancements to warranty services are available through HPE Care Pack services or customized service agreements. Hard drives have either a one year or three year warranty; refer to the specific hard drive QuickSpecs for details.

NOTE: Server Warranty includes 3-Year Parts, 1-Year Labor, 1-Year Onsite support with next business day response. Warranty repairs may be accomplished through the use of Customer Self Repair (CSR) parts. These parts fall into two categories: 1) Mandatory CSR parts are designed for easy replacement. A travel and labor charge will result when customers decline to replace a Mandatory CSR part; 2) Optional CSR parts are also designed for easy replacement but may involve added complexity. Customers may choose to have Hewlett Packard Enterprise replace Optional CSR parts at no charge. Additional information regarding worldwide limited warranty and technical support is available at: <http://h17007.www1.hp.com/us/en/enterprise/servers/warranty/>.

Optional Features

Embedded Management	iLO Essentials	HPE iLO Essentials is the preferred license for small and medium business that offers full remote server management capabilities for small and medium business via the Integrated Remote Console (IRC), virtual media, and e-mail based alerts. Learn more about HPE iLO Essentials at http://www.hpe.com/servers/iLO/essentials .
	iLO Scale-Out	HPE iLO Scale-Out is the preferred license built for web hosting, cloud service providers, and high performance computing data centers, managing massive scale out environments for the DL 100 and 10 series servers, not available for ML servers. This license offers sophisticated scripting tools that provides remote access through Text Console via SSH, Dynamic power capping, Email-based Alerting and proactive notifications. For more information, visit http://www.hpe.com/servers/iLO/scale-out .
	iLO Advanced	HPE iLO Advanced licenses offer smart remote functionality without compromise, for all HPE ProLiant servers. The license includes the full integrated remote console, virtual keyboard, video, and mouse (KVM), multi-user collaboration, console record and replay, and GUI-based and scripted virtual media and virtual folders. You can also activate the enhanced security and power management functionality. Learn more about HPE iLO Advanced at http://www.hpe.com/servers/iLOADvanced .
Server Management	HPE Insight Control	HPE Insight Control, lets you deploy, migrate, monitor, remote control, and optimize your IT infrastructure through a single, simple management console. For more information, see http://www.hpe.com/info/insightcontrol .
Rack and Power Infrastructure	HPE Rack and Power Infrastructure products and services create highly efficient and intelligent solutions for existing or new IT data centers. HPE Rack and Power infrastructure solutions – rack infrastructure, power protection and management, performance optimized data centers (PODs) – are the foundation you are looking for to help secure your long-term IT success. These products are designed to help you react to changes in the industry. They deliver efficient, easy-to-use capabilities to manage, monitor, deploy and provision infrastructure from entry to enterprise. As an industry leader, Hewlett Packard Enterprise is uniquely positioned to address the key concerns of power, cooling, cable management and system access. Learn more at HPE Rack and Power Infrastructure .	
High Performance Clusters	HPE Cluster Platforms are specifically engineered, factory-integrated large-scale ProLiant clusters optimized for High Performance Computing, with a choice of servers, networks and software. Operating system options include specially priced offerings for Red Hat Enterprise Linux and SUSE Linux Enterprise Server, as well as Microsoft Windows HPEC Server. A Cluster Platform Configurator simplifies ordering. http://www.hp.com/go/clusters . HPE Insight Cluster Management Utility (CMU) is a Hewlett Packard Enterprise licensed and supported suite of tools that are used for lifecycle management of hyperscale clusters of Linux ProLiant systems. CMU includes software for the centralized provisioning, management and monitoring of nodes. CMU makes the administration of clusters user friendly, efficient, and effective. http://www.hp.com/go/cmu . NOTE: High Performance Computing (HPC) interconnect technologies are available for this server as part of the HPE Cluster Platform portfolio. These high-speed InfiniBand and Gigabit interconnects are fully supported by Hewlett Packard Enterprise when integrated within a Hewlett Packard Enterprise cluster. Flexible, validated solutions can be defined with the help of configuration tools. http://www.hp.com/techservers/clusters/ucp/index.html .	
HPC Interconnects	NOTE: High Performance Computing (HPC) interconnect technologies are available for this server under the HPE Cluster Platform product portfolio. These high-speed interconnects are fully supported	

Optional Features

by Hewlett Packard Enterprise when they are part of these configure to order clusters. Solutions can be defined with a lot of flexibility with the help of configuration tools. Please visit the following URL to configure HPEC Clusters with InfiniBand Interconnects: <http://www.hp.com/techservers/clusters/ucp/index.html>.

Storage Software Whether you need to solve a specific data protection, archiving, or storage command and control challenge, or deliver on strategic consolidation, compliance, or continuity initiatives, look no further than Hewlett Packard Enterprise storage software. Our storage software helps you reduce costs, simplify storage infrastructure, protect vital assets and respond faster to business opportunities. Storage software that gets the job done:

- **Data Protection and Recovery Software**
Whether you're a large enterprise or a smaller business, Hewlett Packard Enterprise data protection and recovery software will cost-effectively protect you against disaster and ensure business continuity.
- **Data Archive and Migration Software**
Hewlett Packard Enterprise storage software enables you to comply with data retention and retrieval requirements, improve application performance, and reduce costs by efficiently migrating infrequently accessed or less valuable data to lower cost storage.
- **Storage Resource Management Software (SRM)**
Hewlett Packard Enterprise storage resource management software reduces operational costs and provides the command and control foundation you need to efficiently manage and visualize your physical and virtual environments.
- **Data Replication Software**
Hewlett Packard Enterprise offers array-based and host-based replication software for use in disaster recovery, testing, application development and reporting.
- **Storage Device Management Software**
Maximize your investment in Hewlett Packard Enterprise storage and networking with software that enables hardware-specific configuration, performance tuning and connectivity management.
- **HPE StoreVirtual VSA**
With HPE StoreVirtual VSA you can use the power of virtualization to create a virtual array within your host server. Manage it as a single pool of shared storage capacity, and scale it to match your evolving needs. HPE ProLiant Gen9 servers include a 3-year limited license for HPE StoreVirtual VSA software with 1TB of capacity at no extra cost. Simply select to install HPE StoreVirtual VSA software during server setup within Intelligent Provisioning. More information, instructional videos, and free console management software are available at <http://www.hp.com/go/vsa1TB>.

NOTE: For more information about Storage Software including QuickSpecs, please see: <http://www.hp.com/go/storage/software>.

One Config Simple (SCE) SCE is a guided self-service tool to help sales and non-technical people provide customers with initial configurations in 3 to 5 minutes. You may then send the configuration on for configuration help, or use in your existing ordering processes. If you require "custom" rack configuration or configuration for products not available in SCE, please contact Hewlett Packard Enterprise Customer Business Center or an Authorized Partner for assistance. <https://h22174.www2.hp.com/SimplifiedConfig/Index>.

Service and Support

HPE Support Services

HPE Technology Services delivers confidence, reduces risk and helps customers realize agility and stability. Connect to Hewlett Packard Enterprise to help prevent problems and solve issues faster. HPE Support Services enable you to choose the right service level, length of coverage and response time as you purchase your new server, giving you full entitlement to the support for need for your IT and business.

Connect your devices

Unlock all of the benefits of your technology investment by connecting your products to Hewlett Packard Enterprise. Achieve up to 77%¹ reduction in down time, near 100%² diagnostic accuracy and a single consolidated view of your environment. By connecting, you will receive 24x7 monitoring, pre-failure alerts, automatic call logging, and automatic parts dispatch. HPE Proactive Care Service and HPE Datacenter Care Service customers will also benefit from proactive activities to help prevent issues and increase optimization. All of these benefits are already available to you with your server storage and networking products, securely connected to Hewlett Packard Enterprise support.

1- IDC 2 - HP CSC reports 2014 - 2015

Recommended Support

Standard: HPE Foundation Care 24x7, three-year Support Service

HPE Foundation Care 24x7 gives you access to Hewlett Packard Enterprise 24 hours a day, seven days a week for assistance on resolving issues. This service includes need based Hardware onsite response within four hours. In addition, collaborative software support is included in this service that provides troubleshooting assistance on industry leading software running on your HPE server. Simplify your support experience and make Hewlett Packard Enterprise your first call to help resolve hardware or software problems.

<https://www.hpe.com/h20195/V2/GetDocument.aspx?docname=4AA4-8876ENW&cc=us&lc=en>

Optimized: HPE Proactive Care* with 24x7 coverage, three year Support Service

HPE Proactive Care gives customers an enhanced call experience. When your products are connected to Hewlett Packard Enterprise, Proactive Care helps prevent problems and maintains IT stability by utilizing personalized proactive reports with recommendations and advice. This service combines three years proactive reporting and advice with our 24x7 coverage, four hour hardware response time when there is a problem. This service also includes collaborative software support for Independent Software Vendors (ISVs), (Red Hat, VMWare, Microsoft, etc.) running on your HPE servers.

<https://www.hpe.com/h20195/v2/GetPDF.aspx/4AA3-8855ENW.pdf>

Parts and Materials

Hewlett Packard Enterprise will provide Hewlett Packard Enterprise-supported replacement parts and materials necessary to maintain the covered hardware product in operating condition, including parts and materials for available and recommended engineering improvements.

Parts and components that have reached their maximum supported lifetime and/or the maximum usage limitations as set forth in the manufacturer's operating manual, product QuickSpecs, or the technical product data sheet will not be provided, repaired, or replaced as part of these services.

The defective media retention service feature option applies only to Disk or eligible SSD/Flash Drives replaced by Hewlett Packard Enterprise due to malfunction.

Related Services

HPE Server Hardware Installation

Provides for the basic hardware installation of Hewlett Packard Enterprise branded servers, storage devices and networking options to assist you in bringing your new hardware into operation in a timely and professional manner.

<https://www.hpe.com/h20195/V2/GetPDF.aspx/5981-9356EN.pdf>

HPE Installation and Startup Service

Provides for the installation and startup of Hewlett Packard Enterprise technology including BladeSystems, C-Class enclosure, HPE ProLiant c-Class and Integrity server blades, storage blades, SAN switch blades, HPE Virtual Connect modules (Ethernet and Fibre Channel), Ethernet network interconnects, and InfiniBand, as well as the installation of one supported operating system type (Windows® or Linux).

HPE Technology Services Support Credits

Service and Support

Offer flexible services and technical skills to meet your changing IT demands. With a menu of service that is tailored to suit your needs, you get additional resources and specialist skills to help you maintain peak performance of your IT. Offered as annual credits, you can plan your budgets while proactively responding to your dynamic business.

HPE Education Services

Keep your IT staff trained making sure they have the right skills to deliver on your business outcomes. Book on a class today and learn how to get the most from your technology investment. <http://www.hpe.com/ww/learn>

HPE Support Center

The HPE Support Center is a personalized online support portal with access to information, tools and experts to support Hewlett Packard Enterprise business products. Submit support cases online, chat with Hewlett Packard Enterprise experts, access support resources or collaborate with peers.

Learn more <http://www.hpe.com/support/hpesc>

The Hewlett Packard Enterprise Support Center Mobile App* allows you to resolve issues yourself or quickly connect to an agent for live support. Now, you can get access to personalized IT support anywhere, anytime.

HPE Insight Remote Support and HPE Support Center are available at no additional cost with a Hewlett Packard Enterprise warranty, HPE Support Service or Hewlett Packard Enterprise contractual support agreement.

*HPE Support Center Mobile App is subject to local availability.

For more information: <http://www.hpe.com/services>

Pre-configured Models

For the Standard Features shipped in the "Factory Integrated Models", please see the "Configuration Information - Factory Integrated Models" section.

1. Pre-configured models ship with the configurations below. Options can be selected from the Core or Additional options section of this QuickSpecs.
2. Hewlett Packard Enterprise does not allow factory integration of options into pre-configured models. Any additional options purchased will be shipped separately.
3. If you desire a custom configuration please see "Configuration Information - Factory Integrated Models" section of this QuickSpecs.

NOTE: All Pre-configured Models come populated with some hard drive blanks installed. Should the customer need additional hard drive blanks, they can order more using either P/N 666987-B21: HPE SFF Hard Drive Blank Kit or P/N 666986-B21: HPE LFF Hard Drive Blank Kit.

NOTE: All pre-configured servers ship with a standard 6-foot IEC C-13/C-14 jumper cord (A0K02A). This jumper cord is also included with each standard AC power supply option kit. If a different power cord is required, please check the [ProLiant Power Cables](#) web page.

CAUTION: Hewlett Packard Enterprise recommends that a minimum of two people are required for all Rack Server installations. Please refer to your installation instructions for proper tools and number of people to use for any installation.

	Entry Models				Base Models			
[SKU Number]	833970-B21	833971-B21	778452-B21	778453-B21	833972-B21	833973-B21	778454-B21	778455-B21
Model Name	HPE ProLiant DL180 Gen9 E5-2603v4 8GB-R B140i 4LFF NHP 550W PS Entry Server	HPE ProLiant DL180 Gen9 E5-2603v4 8GB-R B140i 8LFF 550W PS Entry Server	HPE ProLiant DL180 Gen9 E5-2603v3 1P 8GB-R B140i 4LFF NHP SATA 550W PS Entry Server	HPE ProLiant DL180 Gen9 E5-2603v3 1P 8GB-R B140i 8LFF Hot Plug SATA 550W PS Entry Server	HPE ProLiant DL180 Gen9 E5-2609v4 8GB-R H240 8LFF 550W PS Base Server	HPE ProLiant DL180 Gen9 E5-2609v4 8GB-R H240 8SFF 550W PS Base Server	HPE ProLiant DL180 Gen9 E5-2609v3 1P 8GB-R H240 8LFF SAS 550W PS Base Server	HPE ProLiant DL180 Gen9 E5-2609v3 1P 8GB-R H240 8SFF SAS 550W PS Base Server
Processor	Intel® Xeon® E5-2603v4		Intel® Xeon® E5-2603v3		Intel® Xeon® E5-2609v4		Intel® Xeon® E5-2609v3	
Number of Processors	One							
Memory	8GB (1x8GB Registered DIMMs, 2400 MHz) NOTE: Due to processor limitation, these DDR4 DIMMs will operate at 1866 MHz in this model.		8GB (1x8GB Registered DIMMs, 2133 MHz) NOTE: Due to processor limitation, these DDR4 DIMMs will operate at 1600 MHz in this model.		8GB (1x8GB Registered DIMMs, 2400 MHz) NOTE: Due to processor limitation, these DDR4 DIMMs will operate at 1866 MHz in this model.		8GB (1x8GB Registered DIMMs, 2133 MHz) NOTE: Due to processor limitation, these DDR4 DIMMs will operate at 1600 MHz in this model.	
Network Controller	HPE Embedded Dual Port 361i Adapter Network Interface							
Storage Controller	HPE Dynamic Smart Array B140i				HPE H240 FIO Smart Host Bus Adapter			
Hard Drive	None ship standard		None ship standard; includes 4 LFF hard	None ship standard; includes 6 LFF hard	None ship standard		None ship standard; includes 6 LFF hard	None ship standard; includes 6 SFF hard

Pre-configured Models

		drive blanks	drive blanks		drive blanks	drive blanks
Internal Storage	4 LFF HDD Bays (Non Hot Plug)	8 LFF HDD Bays	4 LFF HDD Bays (Non Hot Plug)	8 LFF HDD Bays	8 SFF HDD Bays	8 SFF HDD Bays
Optical Drive Bay	Not Available				1; (Optional: DVD-ROM, DVD-RW)	1; (Optional: DVD-ROM, DVD-RW)
Optical Drive	None					
PCI-Express Slots	3 Standard (1-FL/FH, 2-FH/HL)					
Power Supply	(1) HPE 550W FIO Power Supply					
Fans	2 hot swap fans, non-redundant					
Management	iLO Management (standard), Intelligent Provisioning (standard), iLO Essentials (optional), iLO Scale-out (optional only for DL), iLO Advanced (optional)					
Form Factor	Rack (2U), HPE Easy Install Rails					
Warranty	Server Warranty includes 3-Year Parts, 1-Year Labor, 1-Year Onsite support with next business day response.					

	Storage Models
[SKU Number]	833974-B21
Model Name	HPE ProLiant DL180 Gen9 E5-2623v4 16GB-R P840 12LFF 900W PS Server
Processor	Intel® Xeon® E5-2623v4
Number of Processors	One
Memory	16GB (1x16GB Registered DIMMs, 2400 MHz) NOTE: Due to processor limitation, these DDR4 DIMMs will operate at 2133 MHz in this model.
Network Controller	HPE Embedded Dual Port 361i Adapter Network Interface
Storage Controller	HPE Flexible Smart Array P840/4G Controller
Hard Drive	None ship standard
Internal Storage	12 LFF HDD Bays
Optical Drive Bay	Not Available
PCI-Express Slots	3 Standard (1-FL/FH, 2-FH/HL)
Power Supply	(1) HPE 900W Redundant Power Supply
Fans	4 hot plug fans, redundant
Management	iLO Management (standard), Intelligent Provisioning (standard), iLO Essentials (optional), iLO Scale-out (optional only for DL), iLO Advanced (optional)
Form Factor	Rack (2U), HPE Easy Install Rails
Warranty	Server Warranty includes 3-Year Parts, 1-Year Labor, 1-Year Onsite support with next business day response.

Smart Buy Models

	E5-2600v4 Smart Buy Models		
[SKU Number]	860134-S01	833976-S01	833978-S01
Model Name	HPE ProLiant DL180 Gen9 E5-2609v4 900W PS Server/S-Buy	HPE ProLiant DL180 Gen9 E5-2609v4 1.7GHz 8-core 8GB-R B140i 8LFF 550W PS Server/S-Buy	HPE ProLiant DL180 Gen9 E5-2620v4 2.1GHz 8-core 8GB-R P440/2G 8SFF 900W PS Server/S-Buy
Processor	Intel® Xeon® E5-2609v4	Intel® Xeon® E5-2609v4	Intel® Xeon® E5-2620v4
Number of Processors	One		
Memory	32GB (2x16GB Registered DIMMs, 2400 MHz) NOTE: Due to processor limitation, these DDR4 DIMMs will operate at 1866MHz in this model.	8GB (1x8GB Registered DIMMs, 2400 MHz) NOTE: Due to processor limitation, these DDR4 DIMMs will operate at 1866MHz in this model.	8GB (1x8GB Registered DIMMs, 2400 MHz) NOTE: Due to processor limitation, these DDR4 DIMMs will operate at 2133MHz in this model.
Network Controller	HPE Ethernet 1Gb 2-port i350 Adapter		
Storage Controller	HPE H240 Smart Host Bus Adapter	HPE Dynamic Smart Array B140i Controller	HPE Smart Array P440/2G + Smart Storage Battery
Hard Drive	None ship standard		
Internal Storage	8 LFF HDD Bays		8 SFF HDD Bays
Optical Drive Bay	Not Available		None included; (Optional: DVD-ROM, DVD-RW)
PCI-Express Slots	3 Standard (1-FL/FH, 2-FH/HL)		
Power Supply	Two (2) 900W Power Supplies	One (1) HPE 550W FIO Power Supply	One (1) 900W Redundant Capable Power Supply Kit
Fans	2 hot swap fans, non-redundant		
Management	Standard: iLO Management Optional: iLO Essentials, iLO Advanced, Insight Control		
Form Factor	Rack (2U), HPE Easy Install Rails without Cable Management Arms		
Warranty	3-Year Parts, 1-Year Labor, 1-Year Onsite support with next business day response.		

Smart Buy Models

E5-2600v3 Smart Buy Models		
[SKU Number]	784099-S01	784100-S01
Model Name	HP ProLiant DL180 Gen9 E5-2603v3 1.6GHz 6-core 8GB-R B140i 8LFF 550W PS Server/S-Buy	HP ProLiant DL180 Gen9 E5-2609v3 1.9GHz 6-core 8GB-R H240 8SFF 550W PS Server/S-Buy
Processor	Intel® Xeon® E5-2603v3	Intel® Xeon® E5-2609v3
Number of Processors	One	
Memory	8GB (1x8GB Registered DIMMs, 2133 MHz) NOTE: Due to processor limitation, these DDR4 DIMMs will operate at 1600 MHz in this model.	
Network Controller	HPE Ethernet 1Gb 2-port i350 Adapter	
Storage Controller	HPE Dynamic Smart Array B140i	HPE H240 FIO Smart Host Bus Adapter
Hard Drive	None ship standard	
Internal Storage	8 LFF HDD Bays	8 SFF HDD Bays
Optical Drive Bay	Not Available	None included; (Optional: DVD-ROM, DVD-RW)
PCI-Express Slots	3 Standard (1-FL/FH, 2-FH/HL)	
Power Supply	One (1) HPE 550W FIO Power Supply	
Fans	2 hot swap fans, non-redundant	
Management	Standard: iLO Management Optional: iLO Essentials, iLO Advanced, Insight Control	
Form Factor	Rack (2U), HPE Easy Install Rails	
Warranty	3-Year Parts, 1-Year Labor, 1-Year Onsite support with next business day response.	

Configuration Information - Factory Integrated Models

This section lists some of the steps required to configure a Factory Integrated Model. To ensure only valid configurations are ordered, Hewlett Packard Enterprise recommends the use of an HPE approved configurator. Contact your local sales representative for information on configurable product offerings and requirements.

1. Factory Integrated Models must start with a CTO Server.
2. FIO indicates that this option is only available as a factory installable option.
3. All Factory Integrated Models will be populated with sufficient hard drive blanks based on the number of initial hard drives ordered with the server.
4. Some options may not be integrated at the factory. Contact your local sales representative for additional information.

Step 1: Base Configuration (choose one of the following configurable models)

CTO Server	HPE ProLiant DL180 Gen9 Non-hot Plug LFF Configure-to-order Server	HPE ProLiant DL180 Gen9 Hot Plug 8LFF Configure-to-order Server	HPE ProLiant DL180 Gen9 Hot Plug 8SFF Configure-to-order Server	HPE ProLiant DL180 Gen9 Hot Plug 12LFF Configure-to-order Server
SKU Number	754525-B21	754524-B21	754523-B21	775506-B21
Processor	2 (optional) x HPE Smart Socket Guide			
DIMM Slots	16 DIMM slots for RDIMM, LRDIMM DDR4 Memory			
Storage Controller	HPE Dynamic Smart Array B140i			
PCIe	3 PCIe slots (+3 PCI slots available with upgrade option, second processor required)			
Drive Cage	4LFF or 8LFF Non Hot Plug	8LFF Hot Plug (+4LFF optional field upgradable)	8SFF Hot Plug (+8SFF Optional)	12LFF Hot Plug
Network Controller	HPE Ethernet 1Gb 2-port i350 Adapter			
Fans	2 hot swap fans, non-redundant			
Management	iLO Management (standard), Intelligent Provisioning (standard)			
USB	1 front, 1 internal, 2 rear			
Ears	Optional	HPE Quick Release Ears	HPE Thumbscrew Ears	HPE Quick Release Ears

NOTE: HPE ProLiant DL180 Gen9 Non-hot plug CTO Server (P/N- 754525-B21) supports both 4LFF and 8LFF configurations.

NOTE: Thumb screw ears are not supported on Hot Plug LFF CTO Server.

Step 2: Choose Required Options (only one of the following from each list unless otherwise noted)

HPE Processors

E5-2600v4 series Processors

HPE DL180 Gen9 Intel® Xeon® E5-2620v4 (2.1GHz/8-core/20MB/85W) FIO Processor Kit	801238-L21
HPE DL180 Gen9 Intel® Xeon® E5-2609v4 (1.7GHz/8-core/20MB/85W) FIO Processor Kit	801240-L21
HPE DL180 Gen9 Intel® Xeon® E5-2603v4 (1.7GHz/6-core/15MB/85W) FIO Processor Kit	801241-L21
HPE DL180 Gen9 Intel® Xeon® E5-2650Lv4 (1.7GHz/14-core/35MB/65W) FIO Processor Kit	801243-L21
HPE DL180 Gen9 Intel® Xeon® E5-2630Lv4 (1.8GHz/10-core/25MB/55W) FIO Processor Kit	801244-L21
HPE DL180 Gen9 Intel® Xeon® E5-2623v4 (2,6GHz/4-core/10MB/85W) FIO Processor Kit	801249-L21

Configuration Information - Factory Integrated Models

HPE DL180 Gen9 Intel® Xeon® E5-2660v4 (2GHz/14-core/35MB/105W) FIO Processor Kit	801235-L21
HPE DL180 Gen9 Intel® Xeon® E5-2650v4 (2.2GHz/12-core/30MB/105W) FIO Processor Kit	801236-L21
HPE DL180 Gen9 Intel® Xeon® E5-2640v4 (2.4GHz/10-core/25MB/90W) FIO Processor Kit	801237-L21
HPE DL180 Gen9 Intel® Xeon® E5-2680v4 (2.4GHz/14-core/35MB/120W) FIO Processor Kit	825506-L21
HPE DL180 Gen9 Intel® Xeon® E5-2695v4 (2.1GHz/18-core/45MB/120W) FIO Processor Kit	825510-L21
HPE DL180 Gen9 Intel® Xeon® E5-2683v4 (2.1GHz/16-core/40MB/120W) FIO Processor Kit	825512-L21
HPE DL180 Gen9 Intel® Xeon® E5-2630v4 (2.2GHz/10-core/25MB/85W) FIO Processor Kit	801238-L21

E5-2600v3 series Processors

HP DL180 Gen9 Intel® Xeon® E5-2609v3 (1.9GHz/6-core/15MB/85W) FIO Processor Kit	733925-L21
HP DL180 Gen9 Intel® Xeon® E5-2603v3 (1.6GHz/6-core/15MB/85W) FIO Processor Kit	733929-L21
HP DL180 Gen9 Intel® Xeon® E5-2640v3 (2.6GHz/8-core/20MB/90W) FIO Processor Kit	733916-L21
HP DL180 Gen9 Intel® Xeon® E5-2630v3 (2.4GHz/8-core/20MB/85W) FIO Processor Kit	733918-L21
HP DL180 Gen9 Intel® Xeon® E5-2630Lv3 (1.8GHz/8-core/20MB/55W) FIO Processor Kit	763226-L21
HP DL180 Gen9 Intel® Xeon® E5-2620v3 (2.4GHz/6-core/15MB/85W) FIO Processor Kit	733921-L21
HP DL180 Gen9 Intel® Xeon® E5-2623v3 (3GHz/4-core/10MB/105W) FIO Processor Kit	779830-L21
HP DL180 Gen9 Intel® Xeon® E5-2660v3 (2.6GHz/10-core/25MB/105W) FIO Processor Kit	733912-L21
HP DL180 Gen9 Intel® Xeon® E5-2650v3 (2.3GHz/10-core/25MB/105W) FIO Processor Kit	733914-L21
HP DL180 Gen9 Intel® Xeon® E5-2650Lv3 (1.8GHz/12-core/30MB/65W) FIO Processor Kit	763222-L21

NOTE: If two processors are desired, select one xxxxxx-L21 and one corresponding xxxxxx-B21.

NOTE: Up to two processors supported. Mixing different processor models is not supported.

NOTE: DDR4 speed is the maximum memory speed of the processor. Actual memory speed may depend on the quantity and type of DIMMs installed.

NOTE: When v4 Processor is selected, then only PC4-2400T Memory Kit can be selected.

NOTE: When v3 Processor is selected, then only PC4-2133P Memory Kit can be selected.

NOTE: For the Intel® C600 Chipset E5-2600 Series, the letter preceding the model number indicates the Product Line (E3, E5, E7); 2600x v#, 2 = number of CPUs in a Node, 6 is socket/segment designation, 00 = Processor SKU, x = L for low power SKUs and v# (not yet designated) = version number

HPE Memory

NOTE: Select one or more memory from below

NOTE: LRDIMM and RDIMM are distinct memory technologies and cannot be mixed within a server. The majority of ProLiant Gen9 servers support LRDIMM and RDIMM.

NOTE: HP memory from previous generation servers are not qualified or warranted with this HP ProLiant server. HP SmartMemory is required to realize the performance improvements and enhanced functionality listed in this document for Gen9.

Configuration Information - Factory Integrated Models

NOTE: If only one processor is installed, only half of the total DIMM slots are available. When populating with two processors all DIMM slots are available.

NOTE: Kits described as LP include Low Power DIMMs. For more information on ProLiant Energy Efficient Features, see: <http://www.hp.com/go/proliant-energy-efficient>.

NOTE: Depending on the memory configuration and processor model, the memory speed may run at 2133MHz, 1866MHz, 1600MHz or 1333MHz. Please see Memory Population Table or Online Memory Configuration Tool at: <http://www.hp.com/go/ddr4config>.

Registered DIMMs (RDIMMs) for E5-2600v4 Series

HPE 8GB (1x8GB) Single Rank x8 DDR4-2400 CAS-17-17-17 Registered Memory Kit	805347-B21
HPE 16GB (1x16GB) Single Rank x4 DDR4-2400 CAS-17-17-17 Registered Memory Kit	805349-B21
HPE 16GB (1x8GB) Dual Rank x4 DDR4-2400 CAS-17-17-17 Registered Memory Kit	836220-B21
HPE 32GB (1x8GB) Dual Rank x4 DDR4-2400 CAS-17-17-17 Registered Memory Kit	805351-B21

Load Reduced DIMMs (LRDIMMs) for E5-2600v4 Series

HP 32GB (1x32GB) Dual Rank x4 DDR4-2400 CAS-17-17-17 Load Registered Memory Kit	805353-B21
HP 64GB (1x64GB) Quad Rank x4 DDR4-2400 CAS-17-17-17 Load Registered Memory Kit	805358-B21

HPE Standard Memory for E5-2600v4 Series

HPE 8GB (1x8GB) Single Rank x8 DDR4-2400 CAS-17-17-17 Registered Standard Memory Kit	851353-B21
--	------------

NOTE: These are standard memory DIMMs with no SmartMemory features.

Registered DIMMs (RDIMMs) for E5-2600v3 Series

HP 4GB (1x4GB) Single Rank x8 DDR4-2133 CAS-15-15-15 Registered Memory Kit	726717-B21
HP 8GB (1x8GB) Single Rank x4 DDR4-2133 CAS-15-15-15 Registered Memory Kit	726718-B21
HP 8GB (1x8GB) Dual Rank x8 DDR4-2133 CAS-15-15-15 Registered Memory Kit	759934-B21
HP 16GB (1x16GB) Dual Rank x4 DDR4-2133 CAS-15-15-15 Registered Memory Kit	726719-B21
HP 32GB (1x32GB) Dual Rank x4 DDR4-2133 CAS-15-15-15 Registered Memory Kit	728629-B21

Load Reduced DIMMs (LRDIMMs) for E5-2600v3 Series

HP 16GB (1x16GB) Dual Rank x4 DDR4-2133 CAS-15-15-15 Load Reduced Memory Kit	726720-B21
HP 32GB (1x32GB) Quad Rank x4 DDR4-2133 CAS-15-15-15 Load Reduced Memory Kit	726722-B21

HPE Standard Memory for E5-2600v3 Series

HP 4GB (1x4GB) Single Rank x8 DDR4-2133 CAS-15-15-15 Registered Standard Memory Kit	803026-B21
HP 8GB (1x8GB) Single Rank x4 DDR4-2133 CAS-15-15-15 Registered Standard Memory Kit	803028-B21

NOTE: These are standard memory DIMMs with no SmartMemory features.

HPE I/O Expansion Options

HP DL180 Gen9 3 Slot x8 PCI-E Riser Kit	725569-B21
HP DL180 Gen9 x16 PCI-E Riser Kit	725570-B21

NOTE: Must be selected to support x16 options.

HP DL180 Gen9 FlexibleLOM Enablement Kit	780965-B21
--	------------

NOTE: No other FlexibleLOM options may be selected if this Enablement Kit is selected.

HPE Power Supplies

NOTE: Mixing of power supplies in the same server is not supported. All power supplies must be of the same input voltage, output rating, and efficiency rating. If non-matching power supplies are installed, you may receive an error message and/or experience operational issues with your server.

Configuration Information - Factory Integrated Models

NOTE: Prior to selecting a power supply option, it is highly recommended that you review your server configuration in the HP Power Advisor tool to determine the right size power supply for your server configuration. The HP Power Advisor is located at: <http://www.hp.com/go/hppoweradvisor>

HP Entry-Level Power Supplies

HP 550W FIO Power Supply Kit 730941-B21

NOTE: Only one may be selected. The above power supply option is 80Plus Silver-certified with an efficiency rating of up to 89%. Power specifications and technical content for all HP Server power supplies can be found at: <http://www.hp.com/go/proliant/powersupply>.

HPE 900W AC 240VDC Power Input FIO Module 828734-B21

NOTE: HP Server RPS FIO Backplane Kit (828735-B21) is required for this power supply.

NOTE: Up to two of these option kits can be installed in one system.

HPE 900W AC 240VDC Power Backplane FIO Kit 828735-B21

NOTE: One is required when one or two HPE 900W AC 240VDC Power Input FIO Modules (828734-B21) are ordered.

HPE Storage Controllers

NOTE: One of the cable options below is required to be selected depending on combination of CTO Server and Storage Controller. If not using the embedded B140i controller, must select one of the following HP Storage Controllers and Cable options noted below.

NOTE: HP ProLiant DL180 Gen9 12LFF CTO Server (775506-B21) includes P840 Controller Cable Kit and therefore no cable option is required with that model.

HPE Smart Array Controllers

HP Smart Array P440/4GB FBWC 12Gb 1-port Int FIO SAS Controller 761872-B21

NOTE: May be selected to support SAS Hard Drives if HP ProLiant DL180 Gen9 8SFF CTO Server (754523-B21) or HP ProLiant DL180 Gen9 8LFF CTO Server (754524-B21) is selected in Step 1 above.

NOTE: This controller includes the HP Smart Storage Battery.

HP Smart Array P840/4GB FBWC 12Gb 2-port Int FIO SAS Controller 761874-B21

NOTE: Must be selected if HP ProLiant DL180 Gen9 12LFF CTO Server (775506-B21) is selected and may be selected if HP ProLiant DL180 Gen9 8SFF CTO Server (754523-B21) or HP ProLiant DL180 Gen9 8LFF CTO Server (754524-B21) is selected in Step 1 above.

NOTE: This controller includes the HP Smart Storage Battery.

HPE Smart Host Bus Adapters

HP H240 12Gb 2-ports Int FIO Smart Host Bus Adapter 761873-B21

NOTE: May be selected to support SAS Hard Drives if HP ProLiant DL180 Gen9 8SFF CTO Server (754523-B21) or HP ProLiant DL180 Gen9 8LFF CTO Server (754524-B21) is selected in Step 1 above.

HPE Cable Options

HP DL180 Gen9 8LFF Smart Array Cable Kit 725557-B21

NOTE: Required if 761872-B21 or if 761874-B21 is selected with the HP ProLiant DL180 Gen9 8LFF CTO Server.

HP DL180 Gen9 8SFF Smart Array Cable Kit 725578-B21

NOTE: Required if 761872-B21 or if 761874-B21 is selected with the HP ProLiant DL180 Gen9 8SFF CTO Server.

HP DL180 Gen9 8LFF Hot Plug FIO Cable Kit 774868-B21

NOTE: Required if 761873-B21 is selected or if using embedded B140i with the HP ProLiant DL180 Gen9 8LFF CTO Server.

HP DL180 Gen9 8LFF Non-Hot Plug FIO Cable Kit 774869-B21

NOTE: Required with the HP ProLiant DL180 Gen9 NHP LFF CTO Server and supporting more than four (4) NHP Hard Drives.

Configuration Information - Factory Integrated Models

HP DL180 Gen9 8SFF Hot Plug FIO Cable Kit	774870-B21
NOTE: Required if P/N: 761873-B21 is selected or if using embedded B140i with the HP ProLiant DL180 Gen9 8SFF CTO Server.	
HP DL180 Gen9 4LFF Non-Hot Plug FIO Cable Kit	776447-B21
NOTE: Required with the HP ProLiant DL180 Gen9 NHP LFF CTO Server and supporting four (4) or fewer NHP Hard Drives.	

Step 3: Choose Additional Factory Integratable Options (only one of the following from each list unless otherwise noted)

BIOS Mode	HP Legacy FIO Mode Setting	758959-B22
	NOTE: If B140i is the primary controller, then this option cannot be selected. NOTE: Selecting this option will change the default UEFI BIOS setting into Legacy BIOS Setting.	
Controller State	HP Mfg FIO Enable HBA Mode Setting	792962-B21
	NOTE: Can only be selected with H240 FIO Smart Host Bus Adapter. NOTE: If H240 is the primary controller then RAID is not allowed with this selection.	
	HP AHCI-Enable FIO Setting	801845-B21
NOTE: If B140i is the primary controller then RAID is not allowed with this selection.		
HPE Cooling Options	HP DL180 Gen9 Redundant Fan FIO Kit	779841-B21
NOTE: Upgrades a non-redundant server with one additional hot-plug fan.		
HPE Security	HP DL180 Gen9 Thumbscrew Ear FIO Kit	782641-B21
	NOTE: Thumbscrew ears are available with SFF model only.	
	HPE Quick-Release Latch Rack Ears FIO Kit	725579-B21
NOTE: This option is available for both SFF and LFF models. For 12LFF Model, Quick-Release Ears are mandatory.		
NOTE: This option is required for Security Bezel. This option also provides one front USB 3.0 upgrade.		
HPE Insight Control	HP Insight Control including 1yr 24x7 Support ProLiant ML/DL/BL-bundle Single Server FIO License	C6N36A
	HP Insight Control including 1yr 24x7 Support ProLiant ML/DL/BL-bundle FIO Electronic License	C6N36ABE
HPE Converged Infrastructure Management Software	HPE OneView Advanced (with HPE iLO Advanced)	
	HP OneView for ProLiant DL Server incl 3yr 24x7 Supp FIO Bundle Physical 1 Svr Lic	E5Y43A
	HPE OneView Advanced (without HPE iLO Advanced)	
	HP OneView w/o iLO including 3yr 24x7 Support FIO 1 Server LTU	P8B31A

Step 4: Choose Additional Options for Factory Integration from Core and Additional Options Sections below.

CAUTION: Hewlett Packard Enterprise recommends that a minimum of two people are required for all Rack Server installations. Please refer to your installation instructions for proper tools and number of people to use for any installation.

Core Options

NOTE: Some options may not be integrated at the factory. To ensure only valid configurations are ordered, Hewlett Packard Enterprise recommends the use of an HPE approved configurator. Contact your local sales representative for additional information.

HPE Unique Options	HP DL180 Gen9 Dedicated iLO Management Port Kit	725581-B21
	HP DL180 Gen9 8SFF Hard Drive Cage/Backplane Kit	725572-B21
	HP DL180 Gen9 12LFF Hot Plug Enablement Kit	725574-B21
	NOTE: This can be used only with 8LFF Hot Plug Chassis and contains the controller cables required for upgrade.	
	HP DL180 Gen9 3 Slot x8 PCI-E Riser Kit	725569-B21
	HP DL180 Gen9 x16 PCI-E Riser Kit	725570-B21

HPE Processors **E5-2600v4 series Processors**

HPE DL180 Gen9 Intel® Xeon® E5-2609v4 (1.7GHz/8-core/20MB/85W) Processor Kit	801240-B21
HPE DL180 Gen9 Intel® Xeon® E5-2603v4 (1.7GHz/6-core/15MB/85W) Processor Kit	801241-B21
HPE DL180 Gen9 Intel® Xeon® E5-2650Lv4 (1.7GHz/14-core/35MB/65W) Processor Kit	801243-B21
HPE DL180 Gen9 Intel® Xeon® E5-2630Lv4 (1.8GHz/10-core/25MB/55W) Processor Kit	801244-B21
HPE DL180 Gen9 Intel® Xeon® E5-2620v4 (2.1GHz/8-core/20MB/85W) Processor Kit	801239-B21
HPE DL180 Gen9 Intel® Xeon® E5-2623v4 (2.6GHz/4-core/10MB/85W) Processor Kit	801249-B21
HPE DL180 Gen9 Intel® Xeon® E5-2660v4 (2.0GHz/14-core/35MB/105W) Processor Kit	801235-B21
HPE DL180 Gen9 Intel® Xeon® E5-2650v4 (2.2GHz/12-core/30MB/105W) Processor Kit	801236-B21
HPE DL180 Gen9 Intel® Xeon® E5-2640v4 (2.4GHz/10-core/25MB/90W) Processor Kit	801237-B21
HPE DL180 Gen9 Intel® Xeon® E5-2680v4 (2.4GHz/14-core/35MB/120W) Processor Kit	825506-B21
HPE DL180 Gen9 Intel® Xeon® E5-2695v4 (2.1GHz/18-core/45MB/120W) Processor Kit	825510-B21
HPE DL180 Gen9 Intel® Xeon® E5-2683v4 (2.1GHz/16-core/40MB/120W) Processor Kit	825512-B21
HPE DL180 Gen9 Intel® Xeon® E5-2630v4 (2.2GHz/10-core/25MB/85W) Processor Kit	801238-B21

E5-2600v3 series Processors

HP DL180 Gen9 Intel® Xeon® E5-2609v3 (1.9GHz/6-core/15MB/85W) Processor Kit	733925-B21
HP DL180 Gen9 Intel® Xeon® E5-2603v3 (1.6GHz/6-core/15MB/85W) Processor Kit	733929-B21
HP DL180 Gen9 Intel® Xeon® E5-2640v3 (2.6GHz/8-core/20MB/90W) Processor Kit	733916-B21
HP DL180 Gen9 Intel® Xeon® E5-2630v3 (2.4GHz/8-core/20MB/85W) Processor Kit	733918-B21
HP DL180 Gen9 Intel® Xeon® E5-2620v3 (2.4GHz/6-core/15MB/85W) Processor Kit	733921-B21

Core Options

HP DL180 Gen9 Intel® Xeon® E5-2630Lv3 (1.8GHz/8-core/20MB/55W) Processor Kit	763226-B21
HP DL180 Gen9 Intel® Xeon® E5-2623v3 (3GHz/4-core/10MB/105W) Processor Kit	779830-B21
HP DL180 Gen9 Intel® Xeon® E5-2660v3 (2.6GHz/10-core/25MB/105W) Processor Kit	733912-B21
HP DL180 Gen9 Intel® Xeon® E5-2650v3 (2.3GHz/10-core/25MB/105W) Processor Kit	733914-B21
HP DL180 Gen9 Intel® Xeon® E5-2650Lv3 (1.8GHz/12-core/30MB/65W) Processor Kit	763222-B21

NOTE: Processor upgrade from E5-2600v3 to E5-2600v4 is supported for processors up to 105W. Please refer to DL180 Gen9 User Guide for more details.

HPE Memory

Registered DIMMs (RDIMMs) for E5-2600v4 Series

HP 8GB (1x8GB) Single Rank x8 DDR4-2400 CAS-17-17-17 Registered Memory Kit	805347-B21
HP 16GB (1x16GB) Single Rank x4 DDR4-2400 CAS-17-17-17 Registered Memory Kit	805349-B21
HPE 16GB (1x16GB) Dual Rank x4 DDR4-2400 CAS-17-17-17 Registered Memory Kit	836220-B21
HP 32GB (1x32GB) Dual Rank x4 DDR4-2400 CAS-17-17-17 Registered Memory Kit	805351-B21

NOTE: These DIMMs can only be used with E5-2600v4 processors.

Registered DIMMs (RDIMMs) for E5-2600v3 Series

HP 4GB (1x4GB) Single Rank x8 DDR4-2133 CAS-15-15-15 Registered Memory Kit	726717-B21
HP 8GB (1x8GB) Single Rank x4 DDR4-2133 CAS-15-15-15 Registered Memory Kit	726718-B21
HP 8GB (1x8GB) Dual Rank x8 DDR4-2133 CAS-15-15-15 Registered Memory Kit	759934-B21
HP 16GB (1x16GB) Dual Rank x4 DDR4-2133 CAS-15-15-15 Registered Memory Kit	726719-B21
HP 32GB (1x32GB) Dual Rank x4 DDR4-2133 CAS-15-15-15 Registered Memory Kit	728629-B21

NOTE: These DIMMs can only be used with E5-2600v3 processors.

Load Reduced DIMMs (LRDIMMs) for E5-2600v4 Series

HPE 32GB (1x32GB) Dual Rank x4 DDR4-2400 CAS-17-17-17 Load Reduced Memory Kit	805353-B21
HPE 64GB (1x64GB) Quad Rank x4 DDR4-2400 CAS-17-17-17 Load Reduced Memory Kit	805358-B21

NOTE: These DIMMs can only be used with E5-2600v4 processors.

Load Reduced DIMMs (LRDIMMs) for E5-2600v3 Series

HP 16GB (1x16GB) Dual Rank x4 DDR4-2133 CAS-15-15-15 Load Reduced Memory Kit	726720-B21
HP 32GB (1x32GB) Quad Rank x4 DDR4-2133 CAS-15-15-15 Load Reduced Memory Kit	726722-B21
HP 64GB (1x64GB) Quad Rank x4 DDR4-2133 CAS-15-15-15 Load Reduced Memory Kit	726724-B21

NOTE: These DIMMs can only be used with E5-2600v3 processors.

HPE Standard Memory for E5-2600v4 Series

Core Options

HPE 8GB (1x8GB) Single Rank x8 DDR4-2400 CAS-17-17-17 Registered Standard Memory Kit 851353-B21

NOTE: These DIMMs can only be used with E5-2600v4 processors.

HPE Standard Memory for E5-2600v3 Series

HP 4GB (1x4GB) Single Rank x8 DDR4-2133 CAS-15-15-15 Registered Standard Memory Kit 803026-B21

HP 8GB (1x8GB) Single Rank x4 DDR4-2133 CAS-15-15-15 Registered Standard Memory Kit 803028-B21

NOTE: These DIMMs can only be used with E5-2600v3 processors.

HPE Optical Drives HP DL180 Gen9 Optical Disk Drive Enablement Kit 725582-B21
 HP 9.5mm SATA DVD-ROM JackBlack Gen9 Optical Drive 726536-B21
 HP 9.5mm SATA DVD-RW JackBlack G9 Optical Drive 726537-B21
 HP Mobile USB Non Leaded System DVD RW Drive 701498-B21

NOTE: Optical drive is not supported on LFF models.

HPE Drives

SAS Hot Plug SFF (2.5-inch) Enterprise (ENT) Drives

HP 1.2TB 6G SAS 10K rpm SFF (2.5-inch) SC Dual Port Enterprise 3yr Warranty Hard Drive 718162-B21

HP 900GB 6G SAS 10K rpm SFF (2.5-inch) SC Enterprise 3yr Warranty Hard Drive 652589-B21

HP 600GB 6G SAS 10K rpm SFF (2.5-inch) SC Enterprise 3yr Warranty Hard Drive 652583-B21

HP 450GB 6G SAS 10K rpm SFF (2.5-inch) SC Enterprise 3yr Warranty Hard Drive 652572-B21

HP 300GB 6G SAS 10K rpm SFF (2.5-inch) SC Enterprise 3yr Warranty Hard Drive 652564-B21

HP 1.2TB 12G SAS 10K rpm SFF (2.5-inch) SC Enterprise 3yr Warranty Hard Drive 781518-B21

HP 900GB 12G SAS 10K rpm SFF (2.5-inch) SC Enterprise 3yr Warranty Hard Drive 785069-B21

HP 600GB 12G SAS 10K rpm SFF (2.5-inch) SC Enterprise 3yr Warranty Hard Drive 781516-B21

HP 300GB 12G SAS 10K rpm SFF (2.5-inch) SC Enterprise 3yr Warranty Hard Drive 785067-B21

HP 146GB 6G SAS 15K rpm SFF (2.5-inch) SC Enterprise 3yr Warranty Hard Drive 652605-B21

HP 600GB 12G SAS 15K rpm SFF (2.5-inch) SC Enterprise 3yr Warranty Hard Drive 759212-B21

HP 450GB 12G SAS 15K rpm SFF (2.5-inch) SC Enterprise 3yr Warranty Hard Drive 759210-B21

HP 300GB 12G SAS 15K rpm SFF (2.5-inch) SC Enterprise 3yr Warranty Hard Drive 759208-B21

SAS Hot Plug SFF (2.5-inch) Enterprise 512e Drives

HP 1.8TB 12G SAS 10K rpm SFF (2.5-inch) SC Enterprise 512e 3yr Warranty Hard Drive 791034-B21

HP 600GB 12G SAS 15K rpm SFF (2.5-inch) SC 512e Enterprise 3yr Warranty Hard Drive 748387-B21

SAS Hot Plug SFF (2.5-inch) Midline (MDL) Drives

Core Options

HP 1TB 6G SAS 7.2K rpm SFF (2.5-inch) SC Midline 1yr Warranty Hard Drive	652749-B21
HPE 1TB 12G SAS 7.2K rpm SFF (2.5in) SC Midline 1yr Warranty Hard Drive	832514-B21
SAS Hot Plug SFF (2.5-inch) Midline 512e Drives	
HP 2TB 12G SAS 7.2K rpm SFF (2.5-inch) SC 512e 1yr Warranty Hard Drive	765466-B21
HP 1TB 12G SAS 7.2K rpm SFF (2.5-inch) SC 512e 1yr Warranty Hard Drive	765464-B21
SAS Hot Plug LFF (3.5-inch) Enterprise (ENT) Drives	
HP 600GB 12G SAS 15K rpm LFF (3.5-inch) SC Converter Enterprise 3yr Warranty Hard Drive	765424-B21
HP 450GB 12G SAS 15K rpm LFF (3.5-inch) SC Converter Enterprise 3yr Warranty Hard Drive	737394-B21
HP 300GB 12G SAS 15K rpm LFF (3.5-inch) SC Converter Enterprise 3yr Warranty Hard Drive	737261-B21
SAS Hot Plug LFF (3.5-inch) Midline (MDL) Drives	
HPE 6TB 12G SAS 7.2K rpm LFF (3.5in) SC Midline 1yr Warranty Hard Drive	846514-B21
HP 6TB 6G SAS 7.2K rpm LFF (3.5-inch) SC Midline 1yr Warranty Hard Drive	761477-B21
HP 3TB 6G SAS 7.2K rpm LFF (3.5-inch) SC Midline 1yr Warranty Hard Drive	652766-B21
HP 1TB 6G SAS 7.2K rpm LFF (3.5-inch) SC Midline 1yr Warranty Hard Drive	652753-B21
HPE 4TB 12G SAS 7.2K rpm LFF (3.5-inch) SC Midline 1yr Warranty Hard Drive	818367-B21
HPE 3TB 12G SAS 7.2K rpm LFF (3.5in) SC Midline 1yr Warranty Hard Drive	846528-B21
HPE 2TB 12G SAS 7.2K rpm LFF (3.5-inch) SC Midline 1yr Warranty Hard Drive	818365-B21
HPE 1TB 12G SAS 7.2K rpm LFF (3.5in) SC Midline 1yr Warranty Hard Drive	846524-B21
SAS Hot Plug LFF (3.5-inch) Midline 512e Drives	
HPE 8TB 12G SAS 7.2K rpm LFF (3.5in) 512e SC Midline 1yr Warranty Hard Drive	819201-B21
HP 6TB 12G SAS 7.2K rpm LFF (3.5-inch) SC Midline 512e 1yr Warranty Hard Drive	765259-B21
HP 4TB 12G SAS 7.2K rpm LFF (3.5-inch) SC Midline 512e 1yr Warranty Hard Drive	765257-B21
SAS Hot Plug LFF (3.5-inch) 512e Performance Drives	
HP 6TB 12G SAS 7.2K rpm LFF (3.5-inch) SC 512e Performance 1yr Warranty Hard Drive	793671-B21
HP 4TB 12G SAS 7.2K rpm LFF (3.5-inch) SC 512e Performance 1yr Warranty Hard Drive	793669-B21
SAS Hot Plug LFF (3.5-inch) Midline 512e Helium Drives	
HPE 10TB 12G SAS 7.2K rpm LFF (3.5in) 512e SC Midline 1yr Warranty Hard Drive	857644-B21
HPE 8TB 12G SAS 7.2K rpm LFF (3.5in) 512e SC Midline 1yr Warranty Hard Drive	861590-B21
HP 8TB 12G SAS 7.2K rpm LFF (3.5-inch) SC 512e Helium 1yr Warranty Hard Drive	793703-B21
HP 6TB 12G SAS 7.2K rpm LFF (3.5-inch) SC 512e Helium 1yr Warranty Hard Drive	793699-B21
SATA Hot Plug SFF (2.5-inch) Midline (MDL) Drives	
HP 1TB 6G SATA 7.2K rpm SFF (2.5-inch) SC Midline 1yr Warranty Hard Drive	655710-B21
SATA Hot Plug SFF (2.5-inch) Midline 512e Drives	
HP 2TB 6G SATA 7.2K rpm SFF (2.5-inch) SC 512e 1yr Warranty Hard Drive	765455-B21
HP 1TB 6G SATA 7.2K rpm SFF (2.5-inch) SC 512e 1yr Warranty Hard Drive	765453-B21
SATA Hot Plug LFF (3.5-inch) Midline (MDL) Drives	

Core Options

HPE 6TB 6G SATA 7.2K rpm LFF (3.5in) SC Midline 1yr Warranty Hard Drive	846510-B21
HP 6TB 6G SATA 7.2K rpm LFF (3.5-inch) SC Midline 1yr Warranty Hard Drive	753874-B21
HPE 4TB 6G SATA 7.2K rpm LFF (3.5in) SC Midline 1yr Warranty Hard Drive	861678-B21
HP 4TB 6G SATA 7.2k rpm LFF (3.5-inch) SC Midline 1yr Warranty Hard Drive	693687-B21
HP 3TB 6G SATA 7.2K rpm LFF (3.5-inch) SC Midline 1yr Warranty Hard Drive	628061-B21
HPE 3TB 6G SATA 7.2K rpm LFF (3.5in) SC Midline 1yr Warranty Hard Drive	861693-B21
HPE 2TB 6G SATA 7.2K rpm LFF (3.5in) SC Midline 1yr Warranty Hard Drive	861676-B21
HP 2TB 6G SATA 7.2K rpm LFF (3.5-inch) SC Midline 1yr Warranty Hard Drive	658079-B21
HP 1TB 6G SATA 7.2K rpm LFF (3.5-inch) SC Midline 1yr Warranty Hard Drive	657750-B21
HPE 1TB 6G SATA 7.2K rpm LFF (3.5in) SC Midline 1yr Warranty Hard Drive	861691-B21
HP 500GB 6G SATA 7.2K rpm LFF (3.5-inch) SC Midline 1yr Warranty Hard Drive	658071-B21
SATA Hot Plug LFF (3.5-inch) Midline 512e Drives	
HPE 8TB 6G SATA 7.2K rpm LFF (3.5in) 512e SC Midline 1yr Warranty Hard Drive	819203-B21
HP 6TB 6G SATA 7.2K rpm LFF (3.5-inch) SC Midline 512e 1yr Warranty Hard Drive	765255-B21
HP 4TB 6G SATA 7.2K rpm LFF (3.5-inch) SC Midline 512e 1yr Warranty Hard Drive	765253-B21
SATA Hot Plug LFF (3.5-inch) Midline 512e Performance Drives	
HP 6TB 6G SATA 7.2K rpm LFF (3.5-inch) SC 512e Performance 1yr Warranty Hard Drive	793667-B21
HP 4TB 6G SATA 7.2K rpm LFF (3.5-inch) SC 512e Performance 1yr Warranty Hard Drives	793665-B21
SATA Hot Plug LFF (3.5-inch) Midline 512e Helium Drives	
HPE 10TB 6G SATA 7.2K rpm LFF (3.5in) 512e SC Midline 1yr Warranty Hard Drive	857648-B21
HPE 8TB 6G SATA 7.2K rpm LFF (3.5in) 512e SC Midline 1yr Warranty Hard Drive	861594-B21
HP 6TB 6G SATA 7.2K rpm LFF (3.5-inch) SC 512e Helium 1yr Warranty Hard Drive	793683-B21
SATA Non-Hot Plug LFF (3.5-inch) Midline (MDL) Drives	
HP 3TB 6G SATA 7.2K rpm LFF (3.5-inch) Non-hot plug Midline 1yr Warranty Hard Drive	628065-B21
HP 2TB 6G SATA 7.2K rpm LFF (3.5-inch) Non-hot plug Midline 1yr Warranty Hard Drive	659339-B21
HP 1TB 6G SATA 7.2K rpm LFF (3.5-inch) Non-hot plug Midline 1yr Warranty Hard Drive	659337-B21
HP 500GB 6G SATA 7.2K rpm LFF (3.5-inch) Non-hot plug Midline 1yr Warranty Hard Drive	659341-B21
SATA Non-hot Plug LFF 7.2K (3.5-inch) Standard Drives	
HP 4TB 6G SATA 7.2K rpm LFF (3.5in) Non-hot Plug Standard 1yr Warranty Hard Drive	801888-B21
HP 3TB 6G SATA 7.2K rpm LFF (3.5in) Non-hot Plug Standard 1yr Warranty Hard Drive	801886-B21
HP 2TB 6G SATA 7.2K rpm LFF (3.5in) Non-hot Plug Standard 1yr Warranty Hard Drive	801884-B21
HP 1TB 6G SATA 7.2K rpm LFF (3.5in) Non-hot Plug Standard 1yr Warranty Hard Drive	801882-B21

SSD Selection

Core Options

To streamline the configuration process for HPE ProLiant Gen9 servers and to provide the best product availability, HPE recommends SSDs from the list located here: <https://ssd.hpe.com/recommend>

To further assist with configuration, HPE also offers an SSD Selector Tool located here: <http://ssd.hpe.com>

12G SAS Hot Plug SFF (2.5-inch) Enterprise Mainstream Solid State Drives

HP 1.6TB 12G SAS Mainstream Endurance SFF 2.5-in ENT Mainstream SC 3yr Wty H2 Solid State Drive	779176-B21
HP 800GB 12G SAS Mainstream Endurance SFF 2.5-in ENT Mainstream SC 3yr Wty H2 Solid State Drive	779172-B21
HP 400GB 12G SAS Mainstream Endurance SFF 2.5-in ENT Mainstream SC 3yr Wty H2 Solid State Drive	779168-B21
HP 200GB 12G SAS Mainstream Endurance SFF 2.5-in ENT Mainstream SC 3yr Wty H2 Solid State Drive	779164-B21
HPE 1.6TB 12G SAS Write Intensive-1 SFF (2.5in) SC 3yr Wty Solid State Drive	846432-B21
HPE 800GB 12G SAS Write Intensive-1 SFF (2.5in) SC 3yr Wty Solid State Drive	846430-B21
HP 800GB 12G SAS Write Intensive SFF 2.5-in SC 3yr Wty Solid State Drive	802586-B21
HP 400GB 12G SAS Write Intensive SFF 2.5-in SC 3yr Wty Solid State Drive	802582-B21
HP 200GB 12G SAS Write Intensive SFF 2.5-in SC 3yr Wty Solid State Drive	802578-B21

12G SAS Value Endurance Hot Plug SFF (2.5-inch) Enterprise Value Solid State

HP 1.6TB 12G SAS Value Endurance SFF 2.5-in SC Enterprise Value 3yr Wty Solid State Drive	762263-B21
HP 800GB 12G SAS Value Endurance SFF 2.5-in SC Enterprise Value 3yr Wty Solid State Drive	762261-B21
HPE 3.84TB 12G SAS Read Intensive-3 SFF 2.5-in SC 3yr Wty Solid State Drive	816576-B21
HP 1.92TB 12G SAS Read Intensive SFF 2.5-in SC 3yr Wty Solid State Drive	802891-B21

12G SAS Mixed Use Hot Plug SFF (2.5-inch) Solid State Drives

HPE 3.2TB 12G SAS Mixed Use-3 SFF 2.5-in SC 3yr Wty Solid State Drive	822567-B21
HPE 1.6TB 12G SAS Mixed Use-1 SFF (2.5in) SC 3yr Wty Solid State Drive	846436-B21
HPE 800GB 12G SAS Mixed Use-1 SFF (2.5in) SC 3yr Wty Solid State Drive	846434-B21

12G SAS Hot Plug LFF (3.5-inch) Enterprise Value Solid State Drives

HP 1.6TB 12G SAS Value Endurance LFF 3.5-in SC Enterprise Value 3yr Wty Solid State Drive	762272-B21
HP 800GB 12G SAS Value Endurance LFF 3.5-in SC Enterprise Value 3yr Wty Solid State Drive	762270-B21

6G SATA Hot Plug SFF (2.5-inch) Enterprise Mainstream Solid State Drives

HP 1.2TB 6G SATA Write Intensive-2 SFF 2.5-in SC 3yr Wty Solid State Drive	804677-B21
HP 800GB 6G SATA Write Intensive-2 SFF 2.5-in SC 3yr Wty Solid State Drive	804671-B21
HP 400GB 6G SATA Write Intensive-2 SFF 2.5-in SC 3yr Wty Solid State Drive	804665-B21
HP 200GB 6G SATA Write Intensive-2 SFF 2.5-in SC 3yr Wty Solid State Drive	804639-B21

6G SATA Hot Plug SFF (2.5-inch) Enterprise Value Solid State Drives

HP 3.84TB 6G SATA Read Intensive-3 SFF 2.5-in SC 3yr Wty Solid State Drive	816929-B21
HPE 1.92TB 6G SATA Read Intensive SFF (2.5in) SC 1yr Warranty Solid State Drive	871770-B21
HP 1.6TB 6G SATA Read Intensive-2 SFF 2.5-in SC 3yr Wty Solid State Drive	804605-B21
HPE 960GB 6G SATA Read Intensive SFF (2.5in) SC 1yr Warranty Solid State Drive	871768-B21
HP 800GB 6G SATA Read Intensive-2 SFF 2.5-in SC 3yr Wty Solid State Drive	804599-B21

Core Options

HP 480GB 6G SATA Read Intensive-2 SFF 2.5-in SC 3yr Wty Solid State Drive	804593-B21
HP 240GB 6G SATA Read Intensive-2 SFF 2.5-in SC 3yr Wty Solid State Drive	804587-B21
HP 120GB 6G SATA Read Intensive-2 SFF 2.5-in SC 3yr Wty Solid State Drive	804581-B21
HP 80GB 6G SATA Read Intensive-2 SFF 2.5-in SC 3yr Wty Solid State Drive	804575-B21
6G SATA Hot Plug SFF (2.5-inch) SC Mixed Use Solid State Drives	
HP 800GB 6G SATA Value Endurance SFF 2.5-in SC Enterprise Value 3yr Wty M1 Solid State Drive	764929-B21
HP 480GB 6G SATA Value Endurance SFF 2.5-in SC Enterprise Value 3yr Wty M1 Solid State Drive	764927-B21
HP 240GB 6G SATA Value Endurance SFF 2.5-in SC Enterprise Value 3yr Wty M1 Solid State Drive	764925-B21
HP 120GB 6G SATA Value Endurance SFF 2.5-in SC Enterprise Value 3yr Wty M1 Solid State Drive	764923-B21
HP 1.92TB 6G SATA Mixed Use-3 SFF 2.5-in SC 3yr Wty Solid State Drive	817011-B21
HP 1.6TB 6G SATA Mixed Use-2 SFF 2.5-in SC 3yr Wty Solid State Drive	804631-B21
HP 960GB 6G SATA Mixed Use-3 SFF 2.5-in SC 3yr Wty Solid State Drive	816995-B21
HP 800GB 6G SATA Mixed Use-2 SFF 2.5-in SC 3yr Wty Solid State Drive	804625-B21
HP 480GB 6G SATA Mixed Use-3 SFF 2.5-in SC 3yr Wty Solid State Drive	816985-B21
HP 480GB 6G SATA Mixed Use-2 SFF 2.5-in SC 3yr Wty Solid State Drive	832414-B21
HP 200GB 6G SATA Mixed Use-2 SFF 2.5-in SC 3yr Wty Solid State Drive	804613-B21
6G SATA Hot Plug LFF (3.5-inch) Enterprise Mainstream Solid State Drives	
HP 1.2TB 6G SATA Write Intensive-2 LFF 3.5-in SCC 3yr Wty Solid State Drive	804680-B21
HP 800GB 6G SATA Write Intensive-2 LFF 3.5-in SCC 3yr Wty Solid State Drive	804674-B21
HP 400GB 6G SATA Write Intensive-2 LFF 3.5-in SCC 3yr Wty Solid State Drive	804668-B21
HP 200GB 6G SATA Write Intensive-2 LFF 3.5-in SCC 3yr Wty Solid State Drive	804642-B21
6G SATA Hot Plug LFF (3.5-inch) Enterprise Value Solid State Drives	
HP 3.84TB 6G SATA Read Intensive-3 LFF 3.5-in SC Converter 3yr Wty Solid State Drive	816933-B21
HP 1.6TB 6G SATA Read Intensive-2 LFF 3.5-in SCC 3yr Wty Solid State Drive	804608-B21
HP 800GB 6G SATA Read Intensive-2 LFF 3.5-in SCC 3yr Wty Solid State Drive	804602-B21
HP 480GB 6G SATA Read Intensive-2 LFF 3.5-in SCC 3yr Wty Solid State Drive	804596-B21
HP 240GB 6G SATA Read Intensive-2 LFF 3.5-in SCC 3yr Wty Solid State Drive	804590-B21
HP 120GB 6G SATA Read Intensive-2 LFF 3.5-in SCC 3yr Wty Solid State Drive	804584-B21
HP 80GB 6G SATA Read Intensive-2 LFF 3.5-in SCC 3yr Wty Solid State Drive	804578-B21
6G SATA Hot Plug LFF (3.5-inch) SC Converter Mixed Use Solid State Drives	
HP 1.6TB 6G SATA Mixed Use-2 LFF 3.5-in SCC 3yr Wty Solid State Drive	804634-B21
HP 960GB 6G SATA Mixed Use-3 LFF 3.5-in SC Converter 3yr Wty Solid State Drive	816999-B21
HP 800GB 6G SATA Mixed Use-2 LFF 3.5-in SCC 3yr Wty Solid State Drive	804628-B21
HP 480GB 6G SATA Mixed Use-3 LFF 3.5-in SC Converter 3yr Wty Solid State Drive	816989-B21
HP 480GB 6G SATA Mixed Use-2 LFF 3.5-in SCC 3yr Wty Solid State Drive	832417-B21
HP 200GB 6G SATA Mixed Use-2 LFF 3.5-in SCC 3yr Wty Solid State Drive	804616-B21
M.2 SSD	
HPE 340GB Read Intensive-2 Solid State M.2 Enablement Kit for ProLiant ML/DL Servers	835563-B21

Core Options

HPE Dual 340GB Read Intensive-2 Solid State M.2 Enablement Kit for ProLiant ML/DL Servers 835565-B21

HP 120GB Value Endurance Solid State M.2 Enablement Kit for ProLiant ML/DL Servers 788028-B21

HP Dual 120GB Value Endurance Solid State M.2 Enablement Kit for ProLiant ML/DL Servers 777894-B21

NOTE: M.2 drives go in PCIe slot and use B140i SATA controller only.

Hard Drive Blank Kits

HP Large Form Factor Hard Drive Blank Kit 666986-B21

HP Small Form Factor Hard Drive Blank Kit 666987-B21

Hard Drive Kits

HP DL180 Gen9 8SFF Hard Drive Cage/Backplane Kit 725572-B21

HP DL180 Gen9 12LFF Hot Plug Enablement Kit 725574-B21

HPE Networking

1 Gigabit Ethernet adapters

HP Ethernet 1Gb 4-port 331T Adapter 647594-B21

HP Ethernet 1Gb 2-port 332T Adapter 615732-B21

HP Ethernet 1Gb 2-port 361T Adapter 652497-B21

HP Ethernet 1Gb 4-port 366T Adapter 811546-B21

10 Gigabit Ethernet adapters

HP Ethernet 10Gb 2-port 530SFP Adapter 652503-B21

HP Ethernet 10Gb 2-port 530T Adapter 656596-B21

HP Ethernet 10Gb 2-port 546SFP+ Adapter 779793-B21

HP Ethernet 10Gb 2-port 560SFP+ Adapter 665249-B21

HP Ethernet 10Gb 2-port 561T Adapter 716591-B21

HPE Ethernet 10Gb 2-port 562SFP+ Adapter 727055-B21

NOTE: A minimum of two Gigabytes (2 GB) of server memory is required per each adapter.

NOTE: Direct Attach Cable (DAC) for copper environments or fiber transceivers and cables for fiber-optic environments must be purchased separately. See cables/options below.

25 Gigabit Ethernet adapters

HPE Ethernet 4x25Gb 1-port 620QSFP28 Adapter 817762-B21

FlexibleLOM Adapters

HP Ethernet 1Gb 4-port 331FLR Adapter 629135-B22

HP Ethernet 1Gb 4-port 366FLR Adapter 665240-B21

HP FlexFabric 10Gb 2-port 533FLR-T Adapter 700759-B21

HP FlexFabric 10Gb 2-port 534FLR-SFP+ Adapter 700751-B21

HPE FlexFabric 10Gb 4-port 536FLR-T Adapter 764302-B21

HP Ethernet 10Gb 2-port 546FLR-SFP+ Adapter 779799-B21

HPE FlexFabric 10Gb 2-port 556FLR-T Adapter 794525-B21

HP Ethernet 10Gb 2-port 560FLR-SFP+ Adapter 665243-B21

HP Ethernet 10Gb 2-port 561FLR-T Adapter 700699-B21

HPE Ethernet 10Gb 2-port 562FLR-SFP+ Adapter 727054-B21

HPE InfiniBand

HP InfiniBand FDR 2-port 545QSFP Adapter 702211-B21

HP InfiniBand FDR/Ethernet 10Gb/40Gb 2-port 544+QSFP Adapter 764284-B21

Core Options

HP InfiniBand FDR/Ethernet 10Gb/40Gb 2-port 544+FLR-QSFP Adapter	764285-B21
HP InfiniBand QDR/Ethernet 10Gb 2-port 544+FLR-QSFP Adapter	764286-B21

HPE I/O Expansion Options	HP DL180 Gen9 3 Slot x8 PCI-E Riser Kit	725569-B21
	HP DL180 Gen9 x16 PCI-E Riser Kit	725570-B21
	HP DL180 Gen9 FlexibleLOM Enablement Kit	780965-B21

NOTE: This Enablement Kit is required when FlexibleLOM is selected.

HPE Power Supplies	HPE ProLiant Gen9 Essential Server Power Supplies - Redundant	
	HPE 900W Standard AC 240VDC Power Input Module	775595-B21
	NOTE: This part number can only be bought standalone and is for field integration only.	
	NOTE: RPS Backplane is mandatorily needed with this power input module.	
	HPE 900W Standard AC 240VDC RPS Power Backplane	814835-B21
	NOTE: This part number can only be bought standalone and is for field integration only.	
NOTE: This RPS backplane is mandatorily needed with 900W RPS input module.		
HPE 900W Standard AC 240VDC Redundant Power Supply Kit	820792-B21	
NOTE: This Redundant Power supply kit includes 2 power supply input module and 1 backplane kit.		
NOTE: This part number is both factory installed option and field integratable option.		
NOTE: This Power supply supports both 100-240V AC and 240V DC.		
NOTE: Supports Gold-level efficiency (92%) with a standard C14 inlet connector. No support for HPE Power Discovery Services. Only compatible with select HPE ProLiant Gen9 Essential servers.		
NOTE: HPE 900W Gold (Redundant) AC 240VDC Power Input Module (775595-B21) must be used with Power Backplane (814835-B21).		
NOTE: Each Redundant Power Supply Backplane can support up to two (2) power input modules.		
NOTE: Redundant AC Power Input Modules do not share power. Redundant AC Power Input Module #1 is the primary AC Power Input Module. Redundant AC Power Input Module #2 is the backup AC Power Input Module.		

HPE Computation and Graphics Accelerators	HP NVIDIA Quadro K2200 Graphics Accelerator	J0G89A
	HP DL180 Gen9 Graphic Card Adapter Kit	725576-B21
	NOTE: Must select 2 processors if 2 graphic cards are selected.	
	NOTE: Must select 900W non-redundant power supply when 2 graphic cards are selected.	
	NOTE: Only the above listed Graphics cards are HPE standard supported options in this server.	
	NOTE: The NVIDIA Quadro modules are supported only on 64-bit versions of Linux and Windows operating systems as well as on Virtual Machine client operating systems. The supported bare metal operating systems are RHEL6, SLES 11 and Windows Server 2012 R2.	
NOTE: Please see the HPE Power Advisor for estimated power consumption of your individual system configuration prior to installing GPUs. The HPE Power Advisor is located at: http://www.hp.com/go/hppoweradvisor .		

HPE Cooling Options	HP DL180 Gen9 Redundant Fan Kit	725571-B21
	NOTE: Customers can upgrade to a redundant fan configuration with the purchase of above option kit (contains 2 Fans).	

Additional Options

NOTE: Some options may not be integrated at the factory. To ensure only valid configurations are ordered, Hewlett Packard Enterprise recommends the use of an HPE approved configurator. Contact your local sales representative for additional information.

HPE Insight Software	HPE Insight Control	
	HPE Insight Control including 1yr 24x7 Technical Support and Updates 1-server LTU	C6N27A
	HPE Insight Control including 1yr 24x7 TSU E-LTU	C6N28ABE
	HPE Insight Management Media Kit	C6N31A
NOTE: Electronic and Flexible-Quantity licenses can be used to purchase multiple licenses with a single activation key.		
NOTE: Customer will receive a license entitlement certificate. The license entitlement certificate must be redeemed online or via fax in order to obtain the license activation key(s). Includes one year of 24 x 7 HPE Software Technical Support and Update Service.		
NOTE: Licenses ship without media. The HPE Insight Control Media Kit can be ordered separately, or can be downloaded at: http://www.hp.com/go/insightupdates .		
NOTE: For additional license options please see the QuickSpecs at: https://www.hpe.com/h20195/v2/GetHTML.aspx?docname=c04123391 .		

Embedded Management	HPE iLO Advanced	
	HPE iLO Advanced including 1yr 24x7 Technical Support and Updates 1-server LTU	512485-B21
	HPE iLO Advanced including 3yr 24x7 Tech Support and Updates 1-server LTU	BD505A
	HPE iLO Advanced including 1yr 24x7 Technical Support and Updates E-LTU	E6U59ABE
	HPE iLO Advanced including 3yr 24x7 Technical Support and Updates E-LTU	E6U64ABE
	HPE iLO Essentials	
	HPE iLO Essentials including 3yr 24x7 Tech Support and Updates 1-server LTU	BD774A
	HPE iLO Essentials including 1yr 24x7 Tech Support and Updates 1-server LTU	BD775A
	HPE iLO Essentials including 3yr 24x7 Technical Support and Updates E-LTU	E6U61ABE
	HPE iLO Essentials including 1yr 24x7 Technical Support and Updates E-LTU	E6U62ABE
	HPE iLO Scale-out	
	HPE iLO Scale-Out 3yr 24x7 Tech Support and Updates Flexible Quantity LTU	BD776A
	HPE iLO Scale-Out including 3yr 24x7 Tech Support and Updates Flex Qty E-LTU	BD776AAE
	HPE iLO Scale-Out including 3yr 24x7 Tech Support and Updates Tracking LTU	BD777A
HPE iLO Scale-Out 1yr 24x7 Tech Support and Updates Flexible Quantity LTU	BD778A	
HPE iLO Scale-Out including 1yr 24x7 Tech Support and Updates Flex Qty E-LTU	BD778AAE	
HPE iLO Scale-Out including 1yr 24x7 Tech Support and Updates Tracking LTU	BD779A	

HPE Converged Infrastructure Management Software	HPE OneView Advanced (with HPE iLO Advanced)	
	HPE OneView including 3yr 24x7 Support Physical 1-server LTU	E5Y34A
	HPE OneView including 3yr 24x7 Support Flexible Quantity E-LTU	E5Y35AAE
	HPE OneView Physical Media Kit LTU	E5Y37A
NOTE: Full licenses of HPE OneView Advanced also provide the right-to-use HPE Insight Control without additional charge.		
NOTE: Server provisioning (via 'HPE Insight Control server provisioning') is licensed as part of HPE OneView Advanced and provides multi-server OS and driver provisioning. Media kit #BD883A can be ordered for a physical copy of this software (USB flash drive).		

Additional Options

NOTE: Licenses ship without media. The HPE OneView Media Kit can be ordered separately, or can be downloaded at: <http://www.hp.com/go/oneview>.

NOTE: Electronic and Flexible-Quantity licenses can be used to purchase multiple licenses with a single activation key.

HPE OneView Advanced (without HPE iLO Advanced)

HPE OneView w/o iLO including 3yr 24x7 Support 1-server LTU	P8B24A
HPE OneView w/o iLO including 3yr 24x7 Support Track 1-server LTU	P8B25A
HPE OneView w/o iLO including 3yr 24x7 Support Flexible Quantity E-LTU	P8B26AAE

Software Options for HPE OneView Advanced

HPE Operations Analytics for HPE OneView LTU	K8G29A
HPE Operations Analytics for HPE OneView E-LTU	K8G29AAE

NOTE: For use in environments where HPE OneView Advanced is licensed and deployed.

High Performance Clusters HPE Cluster Management Utility

HPE Insight Cluster Management Utility 1yr 24x7 Flexible LTU	QL803B
HPE Insight Cluster Management Utility 3yr 24x7 Flexible LTU	BD476A
HPE Insight Cluster Management Utility Media	BD477A

NOTE: These part numbers can be used to purchase one certificate for multiple licenses and support with a single activation key. Each license is for one node (server). Customer will receive a printed end user license agreement and license entitlement certificate via physical shipment. The license entitlement certificate must be redeemed online in order to obtain a license key. Customer also will receive a support agreement.

NOTE: For additional license kits please see the [HPE Insight Cluster Management Utility QuickSpecs](#)

HPE PCIe Workload Accelerator Options Value Endurance (VE) PCIe Workload Accelerators

HPE 6.4TB Read Intensive-2 FH/HL PCIe Workload Accelerator	831739-B21
HPE 3.2TB Read Intensive-2 HH/HL PCIe Workload Accelerator	831737-B21
HPE 1.6TB Read Intensive-2 HH/HL PCIe Workload Accelerator	831735-B21
HPE 1.3TB Read Intensive-2 HH/HL PCIe Workload Accelerator	831733-B21

Light Endurance (LE) PCIe Workload Accelerators

HPE 5.2TB FH/HL Light Endurance (LE) PCIe Workload Accelerator	775672-B21
HPE 2.6TB HH/HL Light Endurance (LE) PCIe Workload Accelerator	775670-B21
HPE 1.3TB HH/HL Light Endurance (LE) PCIe Workload Accelerator	775668-B21
HPE 1.0TB HH/HL Light Endurance (LE) PCIe Workload Accelerator	775666-B21

NOTE: Please see the [HPE PCIe Workload Accelerators for ProLiant Servers QuickSpecs](#) for Technical Specifications and additional information.

HPE Security

HP 2U Security Bezel Kit	666988-B21
NOTE: Quick Release Ear option kit (P/N 725579-B21) is required for installing security bezel.	
HP Trusted Platform Module 2.0 Kit	745823-B21

NOTE: HPE Trusted Platform Module 2.0 Option works with Gen9 servers with UEFI Mode not Legacy Mode. It is not compatible with HPE ProLiant Gen8 servers or earlier generation variants.

NOTE: HPE Gen9 servers purchased earlier may need the latest firmware update to be compatible with the TPM 2.0 Option.

Additional Options

NOTE: HPE server systems can have a TPM module (of any type) installed only once. It cannot be replaced with any other TPM module.

HP Trusted Platform Module Option 488069-B21

NOTE: The HPE Trusted Platform Module Option (488069-B21) is the TPM 1.2 version. Compatible server platforms include Gen8 and Gen9 servers.

NOTE: HPE server systems can have a TPM module (of any type) installed only once. It cannot be replaced with any other TPM module.

HPE Storage Controllers

SAS Controllers

HPE Smart Array Controllers

HP Smart Array P440/2GB FBWC 12Gb 1-port Int SAS Controller 820834-B21

NOTE: Includes the HPE Smart Storage Battery.

HP Smart Array P440/4GB FBWC 12Gb 1-port Int SAS Controller 726821-B21

HP Smart Array P441/4GB FBWC 12Gb 2-ports Ext SAS Controller 726825-B21

HP Smart Array P840/4GB FBWC 12Gb 2-ports Int SAS Controller 726897-B21

HP Smart Array P841/4GB FBWC 12Gb 4-ports Ext SAS Controller 726903-B21

HPE Smart Host Bus Adapters

HP H240 12Gb 2-ports Int Smart Host Bus Adapter 726907-B21

HP H241 12Gb 2-ports Ext Smart Host Bus Adapter 726911-B21

HPE Cable Options

HP DL180 Gen9 8LFF Smart Array Cable Kit 725577-B21

HP DL180 Gen9 8SFF Smart Array Cable Kit 725578-B21

NOTE: One of the above cables is required to be selected depending on the combination of chassis and storage controller. Cable option kit descriptions include the right server and storage controller names.

Optional Software

HPE SmartCache No Media 24x7 Technical Support 1-server LTU D7S26A

HPE SmartCache No Media 24x7 Technical Support Flexible LTU D7S27A

HPE SmartCache No Media 24x7 Technical Support E-LTU D7S27AAE

NOTE: HPE SmartCache is supported when one of the supported Smart Array Controllers is installed in the server.

Optional Upgrades

HP 96W Smart Storage Battery with 145mm Cable for DL/ML/SL Servers 727258-B21

NOTE: This option is mandatorily required with HPE Smart Array controllers.

One server can accommodate only 1 Smart Storage Battery that would suffice the requirement of all HPE Smart Array controllers.

HPE Tape Backup

NOTE: For the complete range of tape drives, autoloaders, libraries and media see: <http://www.hp.com/go/tape>. For hardware and software compatibility of HPE tape backup products see: <http://www.hp.com/storage/SPOCK> and <http://www.hp.com/go/ebs>.

NOTE: For Internal drives to be connected to DL servers please make sure that you order rack mount kit as well.

Tape Drives

SAS Rack-Mount Tape Solutions

HPE StoreEver LTO-6 Ultrium 6650 SAS External Tape Drive EH964A

HPE StoreEver LTO-6 Ultrium 6250 Tape Drive in a 1U Rack Mount Kit COL99A

HPE StoreEver LTO-6 Ultrium 6250 External Tape Drive EH970A

HPE StoreEver LTO-5 Ultrium 3000 SAS Tape Drive in a 1U Rack Mount Kit EJ014B

HPE StoreEver LTO-5 Ultrium 3000 SAS External Tape Drive EH958B

HPE StoreEver LTO-5 Ultrium 3280 SAS External Tape Drive EH900B

Additional Options

HPE StoreEver LTO-4 Ultrium 1760 SAS (1) in a 1U Rack Mount Kit	EH946C
HPE StoreEver LTO-4 Ultrium 1760 SAS External Tape Drive	EH920B
HPE StoreEver LTO-3 Ultrium 920 SAS External Tape Drive	EH848B
HPE StoreEver 1U SAS Rack Mount Kit	AE459B
HPE StoreEver LTO-7 Ultrium 15000 Internal Tape Drive	BB873A
HPE StoreEver LTO-7 Ultrium 15000 External Tape Drive	BB874A
HPE DAT Autoloader	
HPE StoreEver 1/8 G2 LTO-6 Ultrium 6250 Fibre Channel Tape Autoloader	C0H19A
HPE StoreEver 1/8 G2 LTO-7 Ultrium 15000 FC Tape Autoloader	N7P34A
HPE StoreEver 1/8 G2 LTO-7 Ultrium 15000 SAS Tape Autoloader	N7P35A
HPE MSL2024 Tape Library	
HPE StoreEver MSL2024 0-drive Tape Library	AK379A
HPE MSL4048 Tape Library	
HPE StoreEver MSL4048 0-drive Tape Library	AK381A
HPE StoreEver MSL6480	
HPE StoreEver MSL6480 Scaleable Expansion Module	QU626A
HPE StoreEver MSL6480 Scalable Base Module	QU625A

HPE Disk Backup	HPE RDX Removable Disk Backup System	
	HPE D3700 Enclosure	QW967A
	HPE D3600 Enclosure	QW968A
	HP RDX+ 500GB External Backup System	B7B66B
	HP RDX+ 1TB External Backup System	B7B69B
	HPE RDX+ External Docking System	C8S07B
	HP RDX 2TB USB3.0 External Disk Backup System	E7X53B
	HPE RDX 3TB USB 3.0 Internal Disk Backup System	P9L71A
	HPE RDX+ 3TB USB 3.0 External Disk Backup System	P9L72A
	HPE StoreOnce 3100 8TB System	BB913A
	HPE StoreOnce 3520 12TB System	BB922A
	HPE StoreOnce 3540 24TB System	BB914A
	HPE StoreOnce 5100 48TB System	BB915A

HPE Storage Options	Emulex Fibre Channel HBAs	
	HPE 81E 8Gb 1-port PCIe Fibre Channel Host Bus Adapter	AJ762B
	HPE 82E 8Gb 2-port PCIe Fibre Channel Host Bus Adapter	AJ763B
	HPE StoreFabric SN1100E 16Gb Single Port Fibre Channel Host Bus Adapter	C8R38A
	HPE StoreFabric SN1100E 16Gb Dual Port Fibre Channel Host Bus Adapter	C8R39A
	QLogic Fibre Channel HBAs	
	HPE 82Q 8Gb 2-port PCIe Fibre Channel Host Bus Adapter	AJ764A
	HPE 81Q 8Gb 1-port PCIe Fibre Channel Host Bus Adapter	AK344A
	HPE StoreFabric SN1000Q 16GB 1-port PCIe Fibre Channel Host Bus Adapter	QW971A
	HPE StoreFabric SN1000Q 16GB 2-port PCIe Fibre Channel Host Bus Adapter	QW972A
	HPE StoreFabric SN1100Q 16Gb Single Port Fibre Channel Host Bus Adapter	P9D93A
	HPE StoreFabric SN1100Q 16Gb Dual Port Fibre Channel Host Bus Adapter	P9D94A
	Converged Network Adapter	
	HPE StoreFabric CN1200E 10Gb Converged Network Adapter	E7Y06A
	HPE StoreFabric CN1100R Dual Port Converged Network Adapter	QW990A
	HPE StoreFabric CN1200E 10GBASE-T Dual Port Converged Network Adapter	N3U51A
	HPE StoreFabric CN1100R 10GBASE-T Dual Port Converged Network Adapter	N3U52A

Additional Options

HPE Disk Storage Systems	Disk Enclosures	
	HP D6000 Dual I/O Module Disk Enclosure	QQ695A
	HP D6000 w/35 2TB 6G SAS 7.2K LFF Dual port MDL HDD 70TB Bundle	QQ697A
	HP D6000 w/35 3TB 6G SAS 7.2K LFF Dual port MDL HDD 105TB Bundle	QQ699A
	HP D6000 w/35 4TB 6G SAS 7.2K LFF Dual Port MDL HDD 140TB Bundle	E7W30A
	HP D6000 w/70 2TB 6G SAS 7.2K LFF Dual port MDL HDD 140TB Bundle	QQ698A
	HP D6000 w/70 3TB 6G SAS 7.2K LFF Dual port MDL HDD 210TB Bundle	QQ700A
	HP D6000 w/70 4TB 6G SAS 7.2K LFF Dual Port MDL HDD 280TB Bundle	E7W31A
	HPE D6000 w/35 8TB 12G SAS 7.2K LFF (3.5in) Dual Port MDL HDD 280TB Bundle	M0T58A
	HPE D6000 w/70 8TB 12G SAS 7.2K LFF (3.5in) Dual Port MDL HDD 560TB Bundle	M0T59A

HPE Data Center Racks	HPE Advanced Series Racks	
	HPE 11648 1075mm Pallet Universal Rack	H6J87A
	HPE 11648 1075mm Shock Universal Rack	H6J88A
	HPE 11642 1075mm Pallet Universal Rack	H6J65A
	HPE 11642 1075mm Shock Universal Rack	H6J66A
	HPE 11642 1200mm Pallet Universal Rack	H6J67A
	HPE 11642 1200mm Shock Universal Rack	H6J68A
	HPE 11636 1075mm Pallet Universal Rack	H6J77A
	HPE 11636 1075mm Shock Universal Rack	H6J78A
	HPE 11622 G2 1075mm Pallet Universal Rack	H6J83A
HPE 11622 G2 1075mm Shock Universal Rack	H6J84A	
HPE 11614 1075mm Shock Universal Rack	H6J82A	

NOTE: Please see the [HPE Advanced Series Racks QuickSpecs](#) for information on additional racks options and rack specifications.

HPE Enterprise Series Racks

HPE 647 1075mm Pallet Intelligent Series Rack	BW911A
HPE 647 1075mm Shock Intelligent Series Rack	BW912A
HPE 647 1200mm Pallet Intelligent Series Rack	BW913A
HPE 647 1200mm Shock Intelligent Series Rack	BW914A
HPE 642 1075mm Pallet Intelligent Series Rack	BW903A
HPE 642 1075mm Shock Intelligent Series Rack	BW904A
HPE 642 1200mm Pallet Intelligent Series Rack	BW907A
HPE 642 1200mm Shock Intelligent Series Rack	BW908A
HPE 636 1075mm Pallet Intelligent Series Rack	BW895A
HPE 636 1075mm Shock Intelligent Series Rack	BW896A
HPE 842 1075mm Pallet Intelligent Series Rack	BW917A
HPE 842 1075mm Shock Intelligent Series Rack	BW918A

NOTE: Please see the [HPE Enterprise Series Racks QuickSpecs](#) for information on additional racks options and rack specifications.

HPE Standard Series Rack

HPE V142 1075mm deep Pallet 100 series Rack	AF046A
---	--------

NOTE: Please see the [HPE Standard Series Racks QuickSpecs](#) for information on additional racks options and rack specifications.

Additional Options

HPE Power Distribution Units (PDUs)	HPE Basic Power Distribution Units (PDU)	
	HPE Basic 1.9kVA/L5-20P 16A/120V Outlets (12) 5-20R/Horizontal NA/JP PDU	H5M54A
	HPE Basic 2.8kVA/L5-30P 24A/120V Outlets (18) 5-20R/Vertical NA/JP PDU	H5M55A
	HPE Basic 3.6kVA/60320 C20 Detachable 16A/230V Outlets (12) C13/Horizontal WW PDU	H5M56A
	HPE Basic 4.9kVA/60320 C20 Detachable 16A/230V Outlets (20) C13/Vertical WW PDU	H5M57A
	HPE Basic 4.9kVA/L6-30P 24A/208V Outlets (20) C13/Vertical NA/JP PDU	H5M58A
	HPE Basic 3Ph 8.6kVA/L15-30P 24A/208V Outlets (18) C13/Vertical NA/JP PDU	H5M61A
	HPE Basic 4.9kVA/L6-30P 24A/208V Outlets (24) C13 (6) C19/Vertical NA/JP PDU	H5M59A
	HPE Basic 8.3kVA/CS8265C 40A/208V Outlets (30) C13 (6) C19/Vertical NA PDU	H5M60A
	HPE Basic 9.2kVA/50A Terminal Block 40A/230V Outlets (30) C13 (6) C19/Vertical WW PDU	H5M75A
	HPE Basic 3Ph 5.7kVA/ L21-20P 16A/120-208V Outlets (24) C13 (3) 5-20R/Vertical NA/JP PDU	H5M63A
	HPE Basic 3Ph 8.6kVA/L21-30P 24A/120-208V Outlets (24) C13 (3) C19 (3) 5-20R/Vertical NA/JP PDU	H5M64A
	HPE Basic 3Ph 8.6kVA/L15-30P 24A/208V Outlets (24) C13 (6) C19/Vertical NA/JP PDU	H5M62A
	HPE Basic 3Ph 11kVA/60309 16A/240V Outlets (36) C13 (6) C19/Vertical NA PDU	H5M67A
	HPE Basic Modular 2.8kVA/L5-30P 24A/120V Outlets (4) C19/Horizontal NA/JP PDU	252663-D71
	HPE Basic Modular 4.9kVA/L6-30P 24A/208V Outlets (4) C19/Horizontal NA/JP Core Only PDU	252663-D74
	HPE Basic Modular 8.3kVA/CS8265C 40A/208V Outlets (4) C19/Horizontal NA/JP PDU	252663-D75
	HPE Basic Modular 3Ph 8.6kVA/L15-30P 24A/208V Outlets (6) C19/Horizontal NA/JP PDU	AF512A
	HPE Basic Modular 3Ph 14.4kVA/CS8365C 40A/208V Outlets (6) C19/Horizontal NA/JP PDU	AF519A
	HPE Basic Modular 3Ph 17.3kVA/60309 60A 4-wire 48A/208V Outlets (6) C19/Horizontal NA/JP PDU	AF511A
	HP 800VA - 277V Input / 230V Output NA Rack Mount Transformer	H3X09A
	NOTE: Please see the HPE Basic Power Distribution Units (PDU) QuickSpecs for information on additional options and product specifications.	
	HPE Metered Power Distribution Units (PDU)	
	HPE Metered 2.8kVA/L5-30P 24A/120V Outlets (12) 5-20R/Horizontal NA/JP PDU	D9N43A
	HPE Metered 3.6kVA/60320 C20 Detachable 16A/230V Outlets (12) C13/Horizontal WW PDU	D9N46A
	HPE Metered 4.9kVA/L6-30P 24A/208V Outlets (12) C13/Horizontal NA/JP PDU	D9N44A
	HPE Metered 3.6kVA/60320 C20 Detachable 16A/230V Outlets (16) C13/Vertical WW PDU	D9N45A
	HPE Metered 4.9kVA/L6-30P 24A/208V Outlets (12) C13/Vertical NA/JP PDU	G9Z05A
	HPE Metered 4.9kVA/L6-30P 24A/208V Outlets (20) C13 (4) C19/Vertical NA/JP PDU	D9N47A

Additional Options

HPE Metered 3Ph 8.6kVA/L15-30P 24A/208V Outlets (18) C13 (3) C19/Vertical NA/JP PDU	D9N51A
HPE Metered 3Ph 8.6kVA/L21-30P 24A/120-208V Outlets (18) C13 (3) C19 (3) 5-20R/Vertical NA/JP PDU	D9N53A
HPE Metered 8.3kVA/CS8265C 40A/208V Outlets (30) C13 (3) C19/Vertical NA PDU	D9N49A
HPE Metered 3Ph 14.4kVA/CS8365C 40A/208V Outlets (12) C13 (12) C19/Vertical NA/JP PDU	D9N58A
HPE Metered 3Ph 16.6kVA/60309 32A-30A 5-wire 24A/230V Outlets (30) C13 (3) C19/Vertical NA/JP PDU	D9N61A
HPE Metered 3Ph 16.6kVA/60309 32A-30A 5-wire 24A/230V Outlets (12) C13 (12) C19/Vertical NA/JP PDU	D9N62A
HPE Metered 3Ph 17.3kVA/60309 60A 4-wire 48A/208V Outlets (24) C13 (3) C19/Vertical NA/JP PDU	D9N54A
HPE Metered 3Ph 17.3kVA/60309 60A 4-wire 48A/208V Outlets (12) C13 (12) C19/Vertical NA/JP PDU	D9N59A
HPE Metered 3Ph 17.3kVA/60309 60A 4-wire 48A/208V Outlets (12) C13 (12) C19/Vertical NA/JP PDU	G9Z07A
HPE Metered 3Ph 19.9kVA/L22-30P 24A/277V Outlets (30) RF-203P- HP/Vertical NA PDU	D9N63A
HP Environmental Sensor for Remote Monitored and Managed PDUs	E2D53A
NOTE: Please see the HPE Metered Power Distribution Units (PDU) QuickSpecs for information on additional options and product specifications.	
HPE Intelligent Power Distribution Unit (PDU)	
HPE Intelligent Modular 4.9kVA/L6-30P 24A/208V Outlets (6) C19/Horizontal NA/JP PDU	AF520A
HPE Intelligent Modular 8.3kVA/CS8265C 40A/208V Outlets (6) C19/Horizontal NA/JP PDU	AF521A
HPE Intelligent Modular 3Ph 8.6kVA/L15-30P 24A/208V Outlets (6) C19/Horizontal NA/JP PDU	AF522A
HPE Intelligent Modular 3Ph 17.3kVA/60309 60A 4-wire 48A/208V (6) C19/Horizontal NA/JP PDU	AF523A
HPE Intelligent Modular 3Ph 17.3kVA/60309 30A 5-wire 24A/240V (6) C19/Horizontal NA/JP PDU	AF901A
HPE Intelligent Modular 3Ph 17.3kVA/IEC 60309 60A 4-wire 48A/208V (12) C19/Horizontal NA/JP PDU	AF535A
HPE Intelligent Modular 4.9kVA/L6-30P 24A/208V Outlets (20) C13 (6) C19/Horizontal NA/JP PDU	AF531A
HPE Intelligent Modular 3Ph 8.6kVA/L15-30P 24A/208V Outlets (20) C13 (6) C19/Horizontal NA/JP PDU	AF532A
HPE Intelligent Modular 3Ph 14.4kVA/CS8365C 40A/208V Outlets (6) C19/Horizontal NA/JP PDU	AF533A
HP 5xC13 Intelligent PDU Extension Bar G2 Kit	AF547A
HP 5xC13 Outlets Power and UID LEDs Pair Standard Extension Bar	AF528A
NOTE: Please see the HPE Intelligent Power Distribution Unit (PDU) QuickSpecs for information on additional options and product specifications.	
HPE Metered and Switched Power Distribution Units (PDU)	
HPE Metered Switched 2.8kVA/L5-30P 24A/120V Outlets (24) 5-20R /Vertical NA/JP PDU	H8B48A
HPE Metered Switched 3.6kVA/60320 C20 Detachable 16A/230V Outlets (7) C13 (1) C19/Vertical WW PDU	H8B49A

Additional Options

HPE Metered Switched 4.9kVA/L6-30P 24A/208V Outlets (20) C13 (4) C19/Vertical NA/JP PDU	H8B50A
HPE Metered Switched 3Ph 8.6kVA/L15-30P 24A/208V Outlets (18) C13 (6) C19/Vertical NA/JP PDU	H8B52A
HPE Metered Switched 3Ph 8.6kVA/L21-30P 24A/208V Outlets (20)C13 (3)C19 (1)5-20R/Vertical NA/JP PDU	H8B53A
HPE Metered Switched 3Ph 14.4kVA/CS8365C 40A/208V Outlets (12) C13 (12) C19/Vertical NA/JP PDU	H8B55A
HPE Metered Switched 3Ph 17.3kVA/60309 4-wire 48A/208V Outlets (12) C13 (12) C19/Vertical NA/JP PDU	H8B56A

NOTE: Please see the [HPE Metered and Switched Power Distribution Units \(PDU\) QuickSpecs](#) for information on additional options and product specifications.

NOTE: To learn more, please visit the [HPE Uninterruptible Power Systems \(UPS\) web page](#).

HPE Rack Mount Consoles, KVM Switches, and Keyboards

HPE Location Discovery Services

HPE Location Discovery Services LCD8500 Kit	TL052A
---	--------

NOTE: Please see the [HPE Location Discovery Services QuickSpecs](#) for information on additional options and product specifications.

HPE Rack Mount Consoles

HP LCD8500 1U US Rackmount Console Kit	AF630A
HP LCD8500 1U US TAA Rackmount Console Kit	AF645A

HPE KVM Switches

HP 0x1x8 G3 KVM Console Switch	AF651A
HP 0x2x16 G3 KVM Console Switch	AF652A
HP TAA 0x2x16 G3 KVM Console Switch	AF653A
HP USB Remote Access Key for G3 KVM Console Switches	AF650A
HPE KVM Console USB/Display Port Interface Adapter	AF654A
HP KVM Console USB Interface Adapter	AF628A
HPE KVM Console USB 8-pack Interface Adapter	AF655A
HP 0x2x16 KVM Server Console Switch G2 with Virtual Media CAC Software	AF618A
HP 0x2x32 KVM Server Console Switch G2 with Virtual Media CAC Software	AF619A
HP KVM Console USB 2.0 Virtual Media CAC Interface Adapter	AF629A
HP 1x4 USB/PS2 KVM Console Switch	AF611A
HP 1x1Ex8 KVM IP Console Switch G2 with Virtual Media CAC Software	AF620A
HP 2x1Ex16 KVM IP Console Switch G2 with Virtual Media CAC Software	AF621A
HP 4x1Ex32 KVM IP Console Switch G2 with Virtual Media CAC Software	AF622A

NOTE: To learn more, please visit the [HPE KVM Switches web page](#)

HPE USB Keyboard and Mouse

HP USB BFR with PVC Free US Keyboard/Mouse Kit	631341-B21
--	------------

Rail Kits

HP 2U Small Form Factor Easy Install Rail Kit	733660-B21
---	------------

NOTE: This applies for both LFF & SFF models and it does not include cable management arm.

HP 2U Cable Management Arm for Easy Install Rail Kit	733664-B21
--	------------

HPE Other Options

HPE Rack LED Light Kit	BW939A
HP Kit LCD 1.83m Latch Display Port Cable	G7T29A
HP ConvergedSystem Door Branding Kit	TK815A
HP ConvergedSystem Rack Light Kit	TK816A
HP ConvergedSystem Rack Side Panel 1075mm Kit	TK817A

Additional Options

HPE Uninterruptible HPE DirectFlow Three Phase UPS

Power Systems (UPS)	Power Unit (1U UPS)	
	HPE R12000 DirectFlow - 1U Rackmount Uninterruptible Power System	G9Y75A
	HPE R12000 DirectFlow - POD 1U Rackmount Uninterruptible Power System	AF478A
	Input/Output Module Options for 1U UPS	
	HPE 30A 400-415 Volt Three Phase NA R10000 DirectFlow UPS IEC309 Input/Output Module	AF489A
	HPE 30A 480 Volt Three Phase NA R12000 DirectFlow UPS L22-30 Input/Output Module	AF491A
	HPE 30A 480 Volt Three Phase NA R12000 DirectFlow UPS IEC309 Input/Output Module	AF492A
	HPE 30A 400-415 Volt Three Phase NA R12000 DirectFlow UPS IEC309 Input/Output Module	G9Y76A
	Power Unit (2U UPS)	
	HPE R18000 DirectFlow - 2U Rackmount Uninterruptible Power System	AF479A
	Input/Output Module Options for 2U UPS	
	HPE 30A 480 Volt Three Phase NA R18000 DirectFlow UPS IEC309 Input/Output Module	AF486A
	HPE 30A 480 Volt Three Phase NA R18000 DirectFlow UPS IEC309 Input/Output Module	AF487A
	HPE 30A 400 Volt Three Phase NA R18000 DirectFlow UPS IEC309 Input/Output Module	D9Q02A
	HPE 30A 400-415V Three Phase NA R18000 DirectFlow UPS 1:1 IEC309 Input/Output Module	AF484A
	NOTE: All Input/Output Modules support dual output outlets except the AF484A.	
	Battery Pack Options	
	HPE DirectFlow UPS - 1U Rackmount Lithium-ion Battery Pack	AF480A
	HPE DirectFlow UPS - 3U Rackmount VRLA Battery Pack	AF482A
	HPE WW DirectFlow Secondary Battery Cable	AF497A
	NOTE: Please see the HPE DirectFlow Three Phase Uninterruptible Power System QuickSpecs for information on additional options and product specifications.	
	HPE Tower UPS	
	HPE T750 G4 UPS Models	
	HPE T750 G4 NA/JP Uninterruptible Power System	J2P85A
	HPE T1000 G4 UPS Models	
	HPE T1000 G4 NA/JP Uninterruptible Power System	J2P86A
	HPE T1500 G4 UPS Models	
	HPE T1500 G4 NA/JP Uninterruptible Power System	J2P87A
	HPE Rack/Tower UPS	
	HPE R/T2200 G4 UPS Models	
	HPE R/T2200 G4 NA/JP Uninterruptible Power System	J2R00A
	HPE DirectFlow UPS Management Card	AF493A
	HPE R/T3000 G4 UPS Models	
	HPE R/T3000 G4 Low Voltage NA/JP Uninterruptible Power System	J2R01A
	HPE R/T3000 G4 High Voltage NA/JP Uninterruptible Power System	J2R02A
	R1500 G4 Models	
	HPE R1500 G4 NA Uninterruptible Power System	J2Q99A
	R7000 Uninterruptible Power System (UPS)	
	HPE R7000 4U 50A High Voltage NA/JP Uninterruptible Power System	AF462A

Additional Options

R5000 Uninterruptible Power System (UPS)

HPE R5000 3U L630 High Voltage NA/JP Uninterruptible Power System AF460A

HPE UPS Options

HPE R/T2200 G4 Extended Runtime Module J2R09A

HPE R/T3000 G4 Extended Runtime Module J2R10A

HPE 2U Rack/Tower UPS Shipping Kit L4Q11A

NOTE: To learn more, please visit the [HPE Uninterruptible Power Systems \(UPS\) web page](#).

HPE USB and SD Options

HPE Flash Media Kits for USB Drives

HPE 32GB microSD Mainstream Flash Media Kit 700139-B21

HPE 8GB microSD Enterprise Mainstream Flash Media Kit 726116-B21

HP Dual 8GB microSD Enterprise Midline USB Kit 741279-B21

HPE Support Services

Foundation Care

HPE 3 year Foundation Care 24x7 DL180 Gen9 Service U7AT3E

HPE 3 year Foundation Care 24x7 wDMR DL180 Gen9 Service U7AT4E

HPE 3 year Foundation Care 24x7 wCDMR DL180 Gen9 Service U7AT5E

Proactive Care

HPE 3 year Proactive Care 24x7 DL180 Gen9 Service U7AT6E

HPE 3 year Proactive Care 24x7 with DMR DL180 Gen9 Service U7AT7E

HPE 3 year Proactive Care 24x7 with CDMR DL180 Gen9 Service U7AT8E

Installation & Start-up Services

HPE Installation ProLiant DL180/DL380e Service U6E81E

HPE Installation and Startup DL180 DL380e Service U6E83E

Memory

Memory Population guidelines

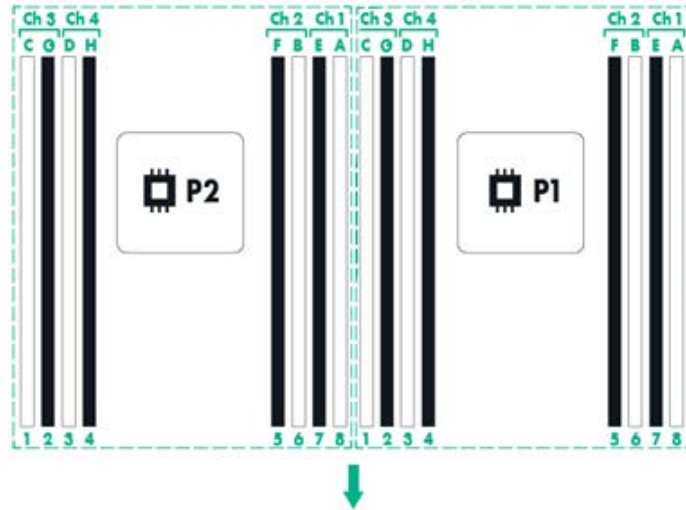

General Memory Population Rules and Guidelines:

- Install DIMMs only if the corresponding processor is installed.
- If only one processor is installed in a two processor system, only half of the DIMM slots are available.
- To maximize performance, it is recommended to balance the total memory capacity between all installed processors and load the channels similarly whenever possible.
- When two processors are installed, balance the DIMMs across the two processors.
- White DIMM slots denote the first slot to be populated in a channel.
- Place the DIMMs with the highest number of ranks in the white slot when mixing DIMMs of different ranks on the same channel.
- Do not mix RDIMMs or LRDIMMs.
- Quad rank RDIMMs are not supported in HPE ProLiant DL180 Gen9 servers.
- Quad rank LRDIMMs are capable of up to two DIMMs per channel.
- DIMMs of different speeds may be mixed in any order; the server will select a common optimal speed.
- The maximum memory speed is a function of the memory type, memory configuration, and processor model.
- The maximum memory capacity is a function of the memory type and number of installed processors.
- To realize the performance memory capabilities listed in this document, HPE SmartMemory is required.

Intel Gen9 Supported Memory Bandwidth for HPE ProLiant Gen9 Intel® Xeon® E5-2600v4 Series Processor Family

Memory Bandwidth and Capacity						
[DIMM Type]	Registered DIMMs (RDIMMs)				Load Reduced (LRDIMMs)	
HPE SKU P/N	805347-B21	805349-B21	836220-B21	805351-B21	805353-B21	805358-B21
DIMM Rank	Single Rank	Single Rank	Dual Rank	Dual Rank	Dual Rank	Quad Rank
DIMM Capacity	8GB	16GB	16GB	32GB	32GB	64GB
Voltage	Std Voltage 1.2V	Std Voltage 1.2V	Std Voltage 1.2V	Std Voltage 1.2V	Std Voltage 1.2V	Std Voltage 1.2V
DRAM Depth [bit]	1G	2G	1G	2G	2G	2G
DRAM Width [bit]	x8	x4	x4	x4	x4	x4
DRAM Density	8Gb	8Gb	4Gb	8Gb	8Gb	8Gb

Memory

CAS Latency	17-17-17	17-17-17	17-17-17	17-17-17	17-17-17	17-17-17
DIMM Native Speed (MT/s)	2400	2400	2400	2400	2400	2400
SLOTS THAT CAN BE POPULATED						
16 slot servers	16	16	16	16	16	16
MAXIMUM CAPACITY (GB)						
	128	256	256	512	512	1024
POPULATED DIMM SPEED (MT/s)						
1 DIMM Per Channel	2400	2400	2400	2400	2400	2400
2 DIMM Per Channel	2133	2133	2133	2133	2400	2400
3 DIMM Per Channel	n/a	n/a	n/a	n/a	n/a	n/a

NOTE: DL180 has 2 DIMMs per channel and hence 3 DIMMs per channel memory speeds are not applicable on DL180.

Intel Gen9 Supported Memory Bandwidth for HPE ProLiant Gen9 Intel® Xeon® E5-2600v3 Series Processor Family

Memory Bandwidth and Capacity								
[DIMM Type]	Registered DIMMs (RDIMMs)					Load Reduced (LRDIMMs)		
HPE SKU P/N	726717-B21	726718-B21	759934-B21	726719-B21	728629-B21	726720-B21	726722-B21	726724-B21
DIMM Rank	Single Rank	Single Rank	Dual Rank	Dual Rank	Dual Rank	Dual Rank	Quad Rank	Quad Rank
DIMM Capacity	4GB	8GB	8GB	16GB	32GB	16GB	32GB	64GB
Voltage	Std Voltage 1.2V	Std Voltage 1.2V	Std Voltage 1.2V	Std Voltage 1.2V	Std Voltage 1.2V	Std Voltage 1.2V	Std Voltage 1.2V	Std Voltage 1.2V
DRAM Depth [bit]	512M	1G	512M	1G	1G	2G	2G	2G
DRAM Width [bit]	x8	x4	x8	x4	x4	x4	x4	x4
DRAM Density	4Gb	4Gb	4Gb	4Gb	4Gb	8Gb	8Gb	8Gb
CAS Latency	15-15-15	15-15-15	15-15-15	15-15-15	15-15-15	15-15-15	15-15-15	15-15-15
DIMM Native Speed (MT/s)	2133	2133	2133	2133	2133	2133	2133	2133
SLOTS THAT CAN BE POPULATED								
16 slot servers	16	16	16	16	16	16	16	16
MAXIMUM CAPACITY (GB)								
	64	128	128	256	512	256	512	1024
POPULATED DIMM SPEED (MT/s)								
1 DIMM Per Channel	2133	2133	2133	2133	2133	2133	2133	2133
2 DIMM Per Channel	2133	2133	2133	2133	2133	2133	2133	2133

Memory

3 DIMM Per Channel	n/a	n/a	n/a	n/a	n/a	n/a	n/a	n/a
---------------------------	-----	-----	-----	-----	-----	-----	-----	-----

NOTE: DL180 has 2 DIMMs per channel and hence 3 DIMMs per channel memory speeds are not applicable on DL180.

DIMM slot and configuration diagram

DIMM slot and configuration diagrams

Basic memory slot & population diagram

- Population order; start with "A" first, "B" second, "C" third, etc.
- When one processor is installed, install DIMMs in sequential alphabetic order: A, B, C, D, E, F.
- When two processors are installed, install DIMMs in sequential alphabetic order: CPU1-A, CPU2-A, CPU1-B, CPU2-B, CPU1-C, CPU2-C

CPU #1 IS PROCESSOR ON RIGHT - LOOKING FROM FRONT OF SERVER

	CPU 1		CPU 2	
	Slot #	population order	Slot #	population order
Chnl 3	1	C	1	C
	2	G	2	G
	CPU 1		CPU 2	
	Slot #	population order	Slot #	population order
Chnl 4	3	D	3	D
	4	H	4	H
	CPU 1		CPU 2	
	Slot #	population order	Slot #	population order
Chnl 2	5	F	5	F
	6	B	6	B
	CPU 1		CPU 2	
	Slot #	population order	Slot #	population order
Chnl 1	7	E	7	E
	8	A	8	A

Memory Speed by Processor Model

Processor Models	Supported Memory Speeds
E5-2609v3, E5-2603v3	1600MT/s
E5-2640v3, E5-2630v3, E5-2620v3, E5-2630Lv3, E5-2623v3	1866MT/s
E5-2660v3, E5-2650v3, E5-2650Lv3	2133MT/s
E5-2609v4, E5-2603v4	1866MT/s
E5-2630Lv4, E5-2620v4, E5-2623v4, E5-2640v4, E5-2630v4	2133MT/s
E5-2650Lv4, E5-2660v4, E5-2650v4, E5-2680v4, E5-2695v4, E5-2683v4	2400MT/s

Standard and Maximum Memory Capacity (Pre-configured Models)

Pre Configured Models	Standard Memory	Maximum Memory Plus Optional Memory	Standard Memory Replaced with Optional Memory

Memory

E5-2623v4	16GB (1x16GB)	496GB (15x32GB, 1x16GB)	1024GB (16x64GB)
E5-2609v4, E5-2609v3, E5-2603v4, E5-2603v3	8GB (1x8GB)	488GB (15x32GB, 1x8GB)	1024GB (16x64GB)

DDR4 memory options part number decoder

NOTE: Capacity references are rounded to the common gigabyte (GB) values.

- 2GB = 2,048MB
- 4GB = 4,096MB
- 8GB = 8,192MB
- 16GB = 16,384MB
- 32GB = 32,768MB
- 64GB = 65,536MB

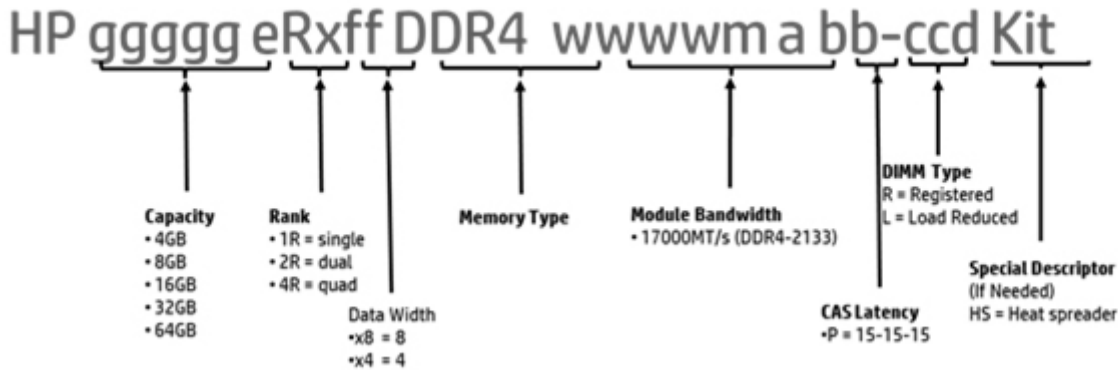

Storage

4-bay LFF non-hot-plug drive model



1-4

4 x LFF SATA Non-Hot Pluggable Hard Drive Bays

8-bay LFF hot-plug drive model

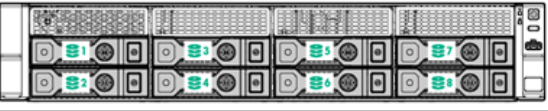

1-8

8 x LFF SATA/SAS/SDD Hot Pluggable Hard Drive Bays

12-bay LFF hot-plug drive model



1-12

12 x LFF SATA/SAS/SDD Hot Pluggable Hard Drive Bays

8-bay SFF hot-plug drive model

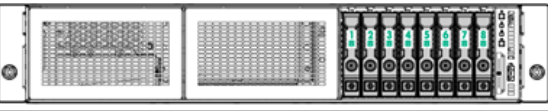

1-8

8 x SFF SATA/SAS/SDD Hot Pluggable Hard drive bays

16-bay SFF hot-plug drive model



1-16

16 x SFF SATA/SAS/SDD Hot Pluggable Hard drive bays

Technical Specifications

System Unit	Dimensions (with bezel)	SFF Drives: 3.44 x 17.54 x 23.9 in (8.75 x 44.55 x 60.7cm) LFF Drives: 3.44 x 17.54 x 23.9 in (8.75 x 44.55 x 60.7 cm)
	Weight (approximate)	Maximum: 47/6 lb (21.59 kg) (all hard drives: front + rear, full power supply, and processor installed) Minimum: 36.58 lb (16.59 kg) (one SFF hard drive, single power supply, and processor installed. HDD not installed)
Input Requirements	Rated Line Voltage	100 to 240 VAC
	Rated Input Current	For 550W Power Supply: 6.7 A (at 100 VAC) 3.3 A (at 200 VAC)
	Rated Input Frequency	47 to 63 Hz
	Rated Input Power	For 550 W Power Supply: < 670 W (at 100 VAC), < 660 W (at 200 VAC),
BTU Rating	Maximum	For 550 W Power Supply: 2201 BTU/hr (at 100 VAC), 2153 BTU/hr (at 200 VAC)
Power Specifications	To review typical system power ratings use the Power Advisor which is available via the online tool located at URL: http://www.hp.com/go/proliant-energy-efficient or http://www.hp.com/go/hppoweradvisor - Click on the system of interest. Example: DL180 Gen9- Follow the instructions of the next screens.	
Power Supply Output	Rated Steady-State Power	For 550 W Power Supply: 550 W (at 100 VAC), 550 W (at 200 VAC),
	Maximum Peak Power	For 550 W Power Supply: 550 W (at 100 VAC), 550 W (at 200 VAC),
System Inlet Temperature	Standard Operating Support	10° to 35°C (50° to 95°F) at sea level with an altitude derating of 1.0°C per every 305 m (1.8°F per every 1000 ft) above sea level to a maximum of 3050 m (10,000 ft), no direct sustained sunlight. Maximum rate of change is 20°C/hr (36°F/hr). The upper limit and rate of change may be limited by the type and number of options installed. System performance during standard operating support may be reduced if operating with a fan fault or above 30°C (86°F).
	Extended Ambient Operating Support	For approved hardware configurations, the supported system inlet range is extended to be: 5° to 10°C (41° to 50°F) and 35° to 40°C (95° to 104°F) at sea level with an altitude derating of 1.0°C per every 175 m (1.8°F per every 574 ft) above 900 m (2953 ft) to a maximum of 3050 m (10,000 ft). The approved hardware configurations for this system are listed at the URL:

Technical Specifications

<http://www.hp.com/servers/ashrae>

For approved hardware configurations, the supported system inlet range is extended to be: 40° to 45°C (104° to 113°F) at sea level with an altitude derating of 1.0°C per every 125 m (1.8°F per every 410 ft) above 900 m (2953 ft) to a maximum of 3050 m (10,000 ft). The approved hardware configurations for this system are listed at the URL:

<http://www.hp.com/servers/ashrae>

System performance may be reduced if operating in the extended ambient operating range or with a fan fault.

NOTE: Supports A3 and A4 extended ambience.

	Non-operating	-30° to 60°C (-22° to 140°F). Maximum rate of change is 20°C/hr (36°F/hr).
Relative Humidity	Operating	Minimum to be the higher (more moisture) of -12°C (10.4°F) dew point or 8% relative humidity. Maximum to be the lower (less moisture) of 24°C (75.2°F) dew point or 90% relative humidity.
(non-condensing)	Non-operating	5% to 95% relative humidity (Rh), 38.7°C (101.7°F) maximum wet bulb temperature, non-condensing.
Altitude	Operating	3048 m (10,000 ft). This value may be limited by the type and number of options installed. Maximum allowable altitude change rate is 457 m/min (1500 ft/min).
	Non-operating	9144 m (30,000 ft). Maximum allowable altitude change rate is 457 m/min (1500 ft/min).
Acoustic Noise	Listed are the declared A-Weighted sound power levels (LWAd) and declared average bystander position A-Weighted sound pressure levels (LpAm) when the product is operating in a 23°C ambient environment. Noise emissions were measured in accordance with ISO 7779 (ECMA 74) and declared in accordance with ISO 9296 (ECMA 109).	
	Idle	
	L WAd	Entry NHP: 5.3 B Entry HP: 5.3 B Base LFF: 5.3 B Base SFF: 5.2 B 12 LFF: 4.9 B
	L pAm	Entry NHP: 37 dBA Entry HP: 37 dBA Base LFF: 37 dBA Base SFF: 36 dBA 12 LFF: 32 dBA
	Operating	
	L WAd	Entry NHP: 5.3 B Entry HP: 5.3 B Base LFF: 5.3 B Base SFF: 5.2 B 12 LFF: 4.9 B
	L pAm	Entry NHP: 38 dBA Entry HP: 37 dBA

Technical Specifications

Base LFF: 37 dBA
 Base SFF: 37 dBA
 12 LFF: 33 dBA

NOTE: Entry NHP Configuration included one Intel E5-2603v4 processor, two 6TB 6G LFF midline SATA non-hot-pluggable HDD, one 8GB DDR4 RDIMMs 2400 MHz, two system fans, one 550W ATX power supply.

NOTE: Entry HP Configuration included one Intel E5-2603v4 processor, two 6TB 6G LFF midline SATA HDD, one 8GB DDR4 RDIMMs 2400 MHz, two system fans, one 550W ATX power supply.

NOTE: Base LFF Configuration included one Intel E5-2609v4 processor, two 6TB 6G LFF midline SAS HDD, one 8GB DDR4 RDIMMs 2400 MHz, two system fans, one 550W ATX power supply, one H240 HBA controller.

NOTE: Base SFF Configuration included one Intel E5-2609v4 processor, two 600GB 12G SFF enterprise SAS HDD, one 8GB DDR4 RDIMMs 2400 MHz, two system fans, one 550W ATX power supply, one H240 HBA controller.

NOTE: 12 LFF Configuration included one Intel E5-2623v4 processor, two 6TB 6G LFF midline SAS HDD, one 16GB DDR4 RDIMMs 2400 MHz, four system fans, one 800W/900W gold AC power input module, one P840 smart array controller with one 4GB cache module, one smart storage 96W battery.

NOTE: Values are subject to change without notification and are for reference only.

NOTE: Performance of system, options, and ancillary equipment will vary depending on the system configurations.

Emissions Classification (EMC)	FCC Rating	Class A
	Normative Standards	CISPR 22; EN55022; EN55024; FCC CFR 47, Pt 15; ICES-003; CNS14336-1; CNS13438; GB4943; GB9254; EN 61000-3-2; EN 61000-3-3; EN 60950-1; IEC 60950-1

NOTE: Product conformance to cited product specifications is based on sample (type) testing, evaluation, or assessment. This product or family of products is eligible to bear the appropriate compliance logos and statements.

NOTE: The listed sound levels apply to standard shipping configurations. Additional options may result in increased sound levels.

HPE Dynamic Smart Array B140i Controller	Number of PCI links	Four
	PCI link rate	4Gb/s
	Storage protocol support	SATA
	SAS/SATA peak data transfer rate	6Gb/s
	Number of SAS/SATA links	10 links
	SAS/SATA connectivity	2x4 connectors; 2x1 connectors
	Expander support	No
	Drives supported (max)	Up to 10 Internal Drives
	RAID support	0, 1, 10, 5 SATA

Technical Specifications

Software management	HPE SSA, SMH, SIM
Warranty	Server warranty
HPE Secure Encryption license	Not Supported
HPE SmartCache License	Not Supported
HPE Smart Storage Administrator	Supported

HPE Embedded Dual Port 361i Adapter	Network Interface	10Base-T/100Base-TX/1000Base-TX
	Compatibility	IEEE 802.3 10Base-T IEEE 802.3ab 1000Base-T IEEE 802.3u 100Base-TX IEEE 1588, IEEE 802.1AS IEEE 802.3az - Energy Efficient Ethernet (EEE)
	Data Transfer Method	PCI Express v 2.0, 5.0 GT/s, two lanes (x2)
	Controller	Intel I350 Powerville
	Network Transfer Rate	10Base-T (Half-Duplex) 10 Mb/s per port, 40 Mb/s combined 10Base-T (Full-Duplex) 20 Mb/s per port, 80 Mb/s combined 100Base-TX (Half-Duplex) 100 Mb/s per port, 400 Mb/s combined 100Base-TX (Full-Duplex) 200 Mb/s per port, 800 Mb/s combined 1000Base-TX (Half and Full-Duplex) 1000 Mb/s per port, 4000 Mb/s combined
	Connector	Two RJ-45
	Cable Support	10 Base-T Categories 3, 4 or 5 UTP; up to 328 ft (100 m) 10/100/1000 Base-TX Category 5 or higher UTP; up to 328 ft (100 m)

Environment-friendly Products and Approach	End-of-life Management and Recycling	Hewlett Packard Enterprise offers end-of-life product return, trade-in, and recycling programs, in many geographic areas, for our products. Products returned to Hewlett Packard Enterprise will be recycled, recovered or disposed of in a responsible manner.
---	---	---

http://www8.hp.com/us/en/hpe/hp-information/livingprogress/environmentalprogress/product-recycling.html#.V-IPA_krKiM

The EU WEEE directive (2002/95/EC) requires manufacturers to provide treatment information for each product type for use by treatment facilities. This information (product disassembly instructions) is posted on the Hewlett Packard Enterprise web site. These instructions may be used by recyclers and other WEEE

Technical Specifications

treatment facilities as well as Hewlett Packard Enterprise OEM customers who integrate and re-sell Hewlett Packard Enterprise equipment.

http://www8.hp.com/us/en/hpe/hp-information/livingprogress/environmentalprogress/product-recycling.html#.V-IPA_krKiM

Summary of Changes

Date	Version History	Action	Description of Change
28-Nov-2016	From Version 18 to 19	Added	Added new Hard Drives offering. Added new HPE Tape Backup options.
		Changed	Maximum Internal Storage
		Removed	Obsolete SKUs were removed from the QuickSpecs.
28-Oct-2016	From Version 17 to 18	Removed	Obsolete Hard Drives were removed from the QuickSpecs.
26-Sep-2016	From Version 16 to 17	Added	Added new 10TB SATA LFF Hard Drives offering.
		Changed	Maximum Internal Storage, HPE PCIe Workload Accelerator Options, and HPE Storage Options were revised.
		Removed	Obsolete SKUs were removed from the QuickSpecs.
10-Jun-2016	From Version 15 to 16	Removed	HPE Dual 32GB microSD Enterprise Midline USB Kit was removed from the QuickSpecs.
6-Jun-2016	From Version 14 to 15	Added	Added new HDD offering to the HPE Drives section. New options added to the HPE Storage Controllers and HPE Disk Backup section.
		Changed	Memory, Memory Protection, Expansion Slots, Maximum Internal Storage, Interfaces, Upgradeability, HPE Networking, HPE Converged Infrastructure Management Software, and HPE Tape Backup were revised.
6-May-2016	From Version 13 to 14	Changed	Memory, Maximum Internal Storage, and Technical Specifications sections were revised.
8-Apr-2016	From Version 12 to 13	Changed	HPE Processors section was revised.
31-Mar-2016	From Version 11 to 12	Added	Added new HPE Smart Memory 2400 MHz memory, Intel Xeon E5-2600v4 processor support, new HPE Trusted Platform Module (TPM) 2.0, new 900W AC/ 240VDC power supply, and new HDD offerings.
		Changed	Power Supplies, Upgradeability, Embedded Management, Service and Support, Pre-configured Models, HPE Security, and Memory sections were revised.
		Removed	Obsolete SKUs were removed from the QuickSpecs.
16-Feb-2016	From Version 10 to 11	Added	New HDD offering was added to HPE Drives.
		Changed	HPE Power Supplies, HPE Computation and Graphics Accelerators, HPE Tape Backup, HPE Disk Backup, HPE Data Center Racks, and HPE Power Distribution Units (PDUs) were revised.
		Removed	Obsolete SKUs were removed from the QuickSpecs.
1-Dec-2015	From Version 9 to 10	Added	New HDD offering was added to HPE Drives. New options added to HPE PCIe Workload Accelerator Options.
		Changed	On System Management Chipset, Embedded Management, and Server utilities were revised. Product images were updated.
		Removed	Obsolete SKUs were removed from the QuickSpecs.

Summary of Changes

28-Sep-2015	From Version 8 to 9	Added	Added new 6Gb SATA Solid State Drives. Added new HPE OneView management software.
		Removed	Obsolete SKUs were removed from the QuickSpecs.
17-Aug-2015	From Version 7 to 8	Added	New Solid State Drives offering was added to Core Options.
		Changed	Maximum Internal Storage was revised.
		Removed	Obsolete SKUs were removed from the QuickSpecs.
1-Jun-2015	From Version 6 to 7	Added	New Hard Drives offering. New HPE OneView licenses added to HPE Converged Infrastructure Management Software. New RDX+ external backup options were added.
		Changed	Maximum Internal Storage was revised. Core options and Additional Options were revised.
		Removed	Obsolete SKUs were removed from the QuickSpecs.
30-Mar-2015	From Version 5 to 6	Added	New Hard Drives offering. Optional Software added to HPE Storage Controllers.
		Changed	HPE Memory, HPE Power Supplies, HPE Storage Controllers, and HPE Disk Storage Systems were revised.
9-Feb-2015	From Version 4 to 5	Added	Added Network controller, new HPE Drives, and new G4 UPS models.
		Changed	HPE Drives, HPE Computation and Graphics Accelerators, HPE Tape Backup, HPE Disk Backup, HPE Rack Mount Consoles, KVM Switches, and Keyboards, HPE Uninterruptible Power Systems (UPS), HPE Networking, and HPE Power Distribution Units (PDUs) sections were revised.
1-Dec-2014	From Version 3 to 4	Changed	Changes made throughout the entire QuickSpecs.
13-Oct-2014	From Version 2 to 3	Added	6G SATA Enterprise Value G1 Solid State Drives were added to Core Option section. HPE PCIe Workload Accelerator Options, HPE USB and SD options were added to the Additional Options section.
		Changed	Standard Features, Optional Features, Configuration Information - Factory Integrated Models, and Memory sections were revised. Warranty was revised in Standard Features section.
19-Sep-2014	From Version 1 to 2	Changed	Changes made throughout the entire QuickSpecs.

Summary of Changes



hpe.com/qref/dl180gen9



Sign up for updates

© Copyright 2016 Hewlett Packard Enterprise Development LP. The information contained herein is subject to change without notice. The only warranties for Hewlett Packard Enterprise products and services are set forth in the express warranty statements accompanying such products and services. Nothing herein should be construed as constituting an additional warranty. Hewlett Packard Enterprise shall not be liable for technical or editorial errors or omissions contained herein.

Intel® and Xeon® are registered trademarks of Intel Corporation in the U.S. and other countries.

Microsoft®, Windows®, and Windows Server® are U.S. registered trademarks of the Microsoft group of companies.

For hard drives, 1GB = 1 billion bytes. Actual formatted capacity is less

c04375610 - 15032 - North America - V19 - 28-November-2016

